



From the Finest Components from Around the World™

# Swim Spas & Swim Pro Spas

## 2026 Owner's Manual

Standard Edition

---

*Hydrotherapy to Heal Minds and Bodies™*

---





*Congratulations, You are now the proud owner of the finest spa built. Now you will experience true comfort and relaxation as you never had before. We at Cal Spas® focus on quality, design, and comfort to create a truly luxurious experience like no other. Welcome to the Cal Spas family.*

It is important that you register your Cal Spas product as soon as possible. This can be done by taking a few minutes to complete an Online registration form on our website. Allowing us to efficiently help you with parts, support, or other inquiries.

**<https://calspas.com/register-your-spa.php>**

### **Locating the Spa Serial Number**

You will need your spas serial number, This serial number is placed on the exterior of the spa. The plate is placed on the lower right hand side when facing the front of the spa. This serial number is unique to your spa, and can be used to order parts, file a warranty claim, and is used in the registration process to activate your spas warranty.

Model: \_\_\_\_\_

Spa Serial Number: \_\_\_\_\_

Purchase Date: \_\_\_\_\_

Dealer's Phone Number: \_\_\_\_\_

Dealer's Address: \_\_\_\_\_

Copyright 2026 Lloyd's Material Supply Company, Inc. All rights reserved.  
Duplication without written consent is strictly prohibited.  
Cal Spas®, Adjustable Therapy System™, ATS™, Cal Premium™, Cal Select™, Cal Stone™, XL™ Heater, and Ultimate Fitness Spa Series™, are registered trademarks. Due to continuous improvement programs, all models, operation, and/or specifications are subject to change without prior notice.

**LTR.2026.1146 Rev D**  
**12/1/2025**

#### **Contact Information**

For customer service or service technicians, please contact your authorized dealer immediately. If you need additional information and/or assistance, contact

**Lloyd's Material Supply Company, Inc.**  
**Customer Service Department**  
**1462 East Ninth Street**  
**Pomona, CA 91766**

Toll Free: 1-800-CAL-SPAS  
Fax: 1-909-629-3890

# Table of Contents

<b>Important Safety Instructions</b>	4	Priming the Spa.....	52
Preparing for Your Spa.....	6	Connecting to Wifi.....	53
Planning the Best Location.....	6	Setting Time of Day.....	56
Clearance for Service Access.....	7	Setting the Filter Cycles.....	57
Foundation Requirements.....	7	Adjust Water Temperatures.....	58
240 Volt Electrical Installation.....	8	Activating Jets/Pumps.....	59
Opening the Front Panel.....	8	Adjust Screen Brightness.....	60
Removing Shipping Materials.....	9	Set Heat Mode & Heat Settings.....	61
Pump & Control Box Placement Diagrams.....	10	Diagnostics.....	63
240 Volt Electrical Specifications.....	16	General Messages & Heater Messages.....	64
Wiring Specifications.....	16	Sensor Related Messages.....	65
GFCI Wiring Diagram USA/Canada.....	17	System Related Messages.....	65
Filling and Powering Up your Spa.....	18	Reminder Messages.....	66
Priming the Pump.....	21	<b>Cal Connect RF Set Up Guide</b>	
<b>Spa Control Systems</b>		Download the Control My Spa App.....	68
<b>Spa Touch 2 Control Panel</b>	22	<b>Spa Operation</b>	
<b>Dual Zone F-1868DZ Spa Controls.....</b>	22	Energy Consumption Tips.....	71
Main Screen & Legend.....	23	Spa Jets & LED Lighting.....	71
Temperature Adjustment.....	24	Diverters, Air Venturis, & Hydrostreamers.....	72
Changing Display Languages.....	25	<b>Water Clarity</b>	
Priming Mode & Ozonator.....	27	The Four Main Focuses of Water Clarity.....	73
Temperature Sensors, Freeze Protection.....	27	Water Quality Terms and Definitions.....	74
Spa Equipment Access.....	28	Water Testing Methods.....	75
Navigation and Value Selection.....	29	Adding Chemicals to the Spa.....	75
Navigation Between Pages.....	29	Balancing Water Chemistry Levels.....	76
The Setting Screen.....	29	Sanitation and Shock.....	77
Dual Temperature Ranges.....	30	Filtration and Cleaning.....	79
Heat Modes (Ready & Rest).....	30	General Water Care Schedule.....	80
Setting the Time of Day.....	30	Generic Names for Chemicals.....	80
Adjusting Filtration.....	31	Common Water Chemistry Questions.....	81
Panel Lock & Unlock.....	31	Bather Load & Ozonator.....	82
Utilities, Panel, Demo Mode, & Fault Log.....	32	Troubleshooting Water Clarity.....	82
Additional Settings.....	33	Chemical Abuse.....	83
General Messages & Heater Messages.....	34	<b>Cleaning and Maintenance</b>	
Sensor Related Messages.....	35	Removing & Re-seating Jets and Pillows.....	84
System Related Messages.....	35	Cleaning the Hydrostreamers.....	84
Reminder Messages.....	36	Spa Cover and Locking System Installation.....	86
<b>TP 700 Control System</b>		Draining your Spa.....	88
Main Screen Icons & Legend.....	39	Winterizing (Cold Climate Draining).....	89
User Interface and Control layout.....	40	Cleaning/Replacing the Filter, Vacation Care.....	89
Menu Navigation & On/Off Switches.....	41	Cleaning Your Spa.....	90
Select and Save Options.....	41	Using the Freedom Sound System.....	90
Main Menu Navigation.....	42	Working Out with Your Swim Spa.....	91
Setting the Time of Day.....	43	Anchor Points for Fitness Straps.....	92
Change the Temperature.....	44	Anchor Points for Fitness Equipment.....	94
Heat Modes (Ready & Rest).....	45	<b>Appendix</b>	
Temperature Ranges.....	46	Replacement Parts.....	100
Restrict Operations, (Lock/Unlock).....	47	Basic Troubleshooting.....	106
Invert Display (Flip/Rotate).....	48	Thermal Creep.....	108
Set Filter Cycle Times.....	48	Warranty Information.....	110
<b>Touch 4 + Control System</b>			
Touch to Start .....	50		
Navigating Menu Icons.....	50		

# IMPORTANT SAFETY INSTRUCTIONS



## READ AND FOLLOW ALL INSTRUCTIONS CAREFULLY

When using and installing this spa, basic safety precautions should always be followed, including.



### **Danger: RISK OF SEVERE INJURY OR DROWNING!**

- NO DIVING, diving may result in injury or death.
- Do not allow children to be in or around the spa unless a responsible adult supervises them.
- Keep the spa cover on and locked when not in use
- See instructions enclosed with your cover for locking procedures.



### **Danger: SUCTION ENTRAPMENT HAZARD, RISK OF SEVERE INJURY OR DROWNING!**

Suction in suction fittings when broken, damaged, cracked, or unsecured can cause severe injury and or death due to the following entrapment hazards.

- **Body Entrapment:** A negative pressure applied to a large portion of the body or limbs can result in entrapment.
- **Hair Entrapment:** Hair can be sucked in or caught within the suction fitting.
- **Evisceration/Disembowelment Entrapment Risk:** Negative pressure applied directly to the intestines through a damaged/unprotected suction outlet. This can result in Evisceration/Disembowelment.
- The suction fittings in this spa are sized to match the specific water flow created by the pump. Should the need arise to replace the suction fittings, or the pump, be sure the flow rates are compatible.
- The suction fitting is made with chemical resistant plastic, that will last over a finite period of time. This component will degrade and become brittle after constant exposure to sanitizers. When performing maintenance on the spa, inspect suction fittings for any cracks or damage.
- When the spa is in operation, suction is created within the suction fittings. Persons within the spa should not be leaning on, stepping on, or making contact with suction fittings.



### **Danger: RISK OF SEVERE INJURY FROM ELECTRIC SHOCK OR DEATH FROM ELECTROCUTION.**

- Install the spa at least 5 feet (1.5 meters) from all metal surfaces. As an alternative, a spa may be installed within 5 feet (1.5 meters) of metal surfaces if each metal surface is permanently bonded by a minimum of 8 gauge AWG solid copper conductor to the outside of the spas control box.
- DO NOT permit any external electrical appliances, such as lights, telephones, radios, television, etc, within 5 feet (1.5 meters) of the spa. Never attempt to operate any electrical device from inside the spa.
- Replace any damaged power cord immediately.
- Never bury any power cord, a proper conduit must be used.
- Connect to a proper grounding-type receptacle or to a proper grounding post in the GFCI and breaker.



### **Warning: RISK OF HYPERTHERMIA (OVER-HEATING) CAUSING SEVERE INJURY, BURNS, WELTS, OR DEATH**

- Water temperature in excess of 104°F (40°C) may be detrimental for your health.
- The spa water should never exceed 104°F (40°C). Water temperatures between 100°F (38°C) and 104°F (40°C) are considered safe for a healthy adult.
- Lower water temperatures are recommended for young children, and when the spa use exceeds 10 minutes.
- Before using the spa, the user should measure the water temperature since the tolerance of water temperature regulating devices varies.
- **Do not use the spa if drugs, alcohol, or prescription medications were consumed before or during use. In an altered state of mind, the human body can not react properly to changes in temperature. This increases your risk of hyperthermia, injury, drowning, or death.**

 **Warning: REDUCE RISK OF HEAT RELATED INJURY OR DEATH**

- Prolonged exposure to hot air or water can induce hyperthermia. Hyperthermia occurs when the internal temperature of the body reaches a level between 3°F (2°C) to 6°F (4°C) above the normal body temperature of 98.6°F (37°C). While using warm spa water has many health benefits, its important to make sure that your body’s core temperature does not rise above 103°F (39.5°C).
- High water temperatures have a high potential for causing fetal damage during pregnancy. Women who are pregnant, or think they are pregnant should always check with their physician prior to spa usage.
- The use of alcohol, drugs or medication before or during spa use may lead to unconsciousness, with the possibility of drowning.
- Persons suffering from obesity, a medical history of heart disease, low or high blood pressure, circulatory system problems or diabetes should consult a physician before using the spa.
- Persons using medications should consult a physician before using the spa since some medications may induce drowsiness or impair judgment. Other medications or drugs may affect heat rate, blood pressure and circulation.

 **HYPERTHERMIA**

- Symptoms of excessive hyperthermia include dizziness, lethargy, drowsiness and fainting. The effects if excessive hyperthermia may include:
  - Failure to perceive heat
  - Failure to recognize the need to exit the spa
  - Unawareness to impending hazards
  - Fetal damage to pregnant woman
  - Physical inability to exit spa
  - Unconsciousness

 **Swim Spa Temperatures**

- When using a swim spa for exercise or for leisurely swimming, never set the swim spa water temperature above 80°F. Temperatures above 80°F can hinder the bodies ability to cool down and cause unnecessary cardiovascular stress.

 **WARNING:** People with infectious diseases or diarrhea should not use a spa or hot tub.

 **WARNING:** To avoid injury, exercise caution when entering or exiting the spa/swim spa.

 **WARNING:** Do not use the spa or swim spa immediately following strenuous exercise.

 **WARNING:** Prolonged immersion in a spa or hot tub may be injurious to your health.

 **CAUTION:** Maintain water chemistry in accordance with the manufacture’s instructions.

 **WARNING: NO DIVING, diving may result in injury or death.**

**READ AND SAVE THESE INSTRUCTIONS**



## Preparing for Your New Portable Spa

### Pre-Delivery Checklist

Most cities and counties require permits for exterior construction and electrical circuits. In addition some communities have codes requiring residential barriers such as a fencing and/or self closing gates on property to prevent children unsupervised access to the property by children. Your dealer can provide information on which permits may be required and how to obtain them prior to the delivery of the spa.

### Before Delivery

- Plan your delivery route
- Choose a suitable location for the spa
- Lay a 5-8 cm concrete slab
- Install dedicated electric supply

### After Delivery

- Place spa on Slab
- Connect electrical components

## Planning the Best Location

### Safety First

Do not place your spa within 10 feet (3m) of overhead power lines.

### Consider How You Will Use Your Spa

How do you intend to use your spa will help you determine where you should position it. For example will you use your spa for recreational be sure to leave plenty of room around it for activity. If you will use it for relaxation and therapy, you will probably want to create a specific mood around it.

### Plan for Your Environment

If you live in a region where it snows in the winter or rains frequently, place your spa near a house entry. BY doing this, you will have a palace to change clothes and not be uncomfortable.

### Consider Your Privacy

In a cold weather climate, bare trees won't provide much privacy. Think of your spa's surroundings during all seasons to determine your best privacy options. Consider the view of your neighbors as well when you plan the location of your spa.

### Provide a View with Your Spa

Think about the direction you will be facing when sitting in your spa. Do you have a special landscaped area in your heart that you find enjoyable? Perhaps there is an area that catches a soothing breeze during the day or a lovely sunset in the evening.

### Keep You Spa Clean

Think about the direction you will be facing when sitting in your spa. Do you have a special landscaped area in your heart that you find enjoyable? Perhaps there is an area that catches a soothing breeze during the day or a lovely sunset in the evening.

### Consider How You Will Use Your Spa

Make sure the spa is positioned so that access to the equipment compartment (front panel) and all side panels are not blocked.

Many people choose to install a decorative structure around their spa with any type of gazebo, remember to allow access to service. It is always best to design special installations so that the spa can still be moved, or lifted off the ground.

## Clearance for Service Access

While you are planning where to locate your spa, you need to determine how much access you will need for service.

All spa models require a minimum of three feet (one meter), of access to all sides of the spa for potential service. For this reason, the spa should never be placed in a manner where any side is permanently blocked. Examples include placing the spa against a building, structural posts, columns, walls, fences, or raised embankments.

If the spa is surrounded by a deck, ensure that there is easy access for service or repair. Decks should have the ability to be accessed or removed easily, some decks are built in segments for easy removal.

Spas require access in all sides in case they need service or repair. Additional service costs can be applied by the servicing dealer if a crane or additional manpower and equipment is needed to access the internals of the spa.

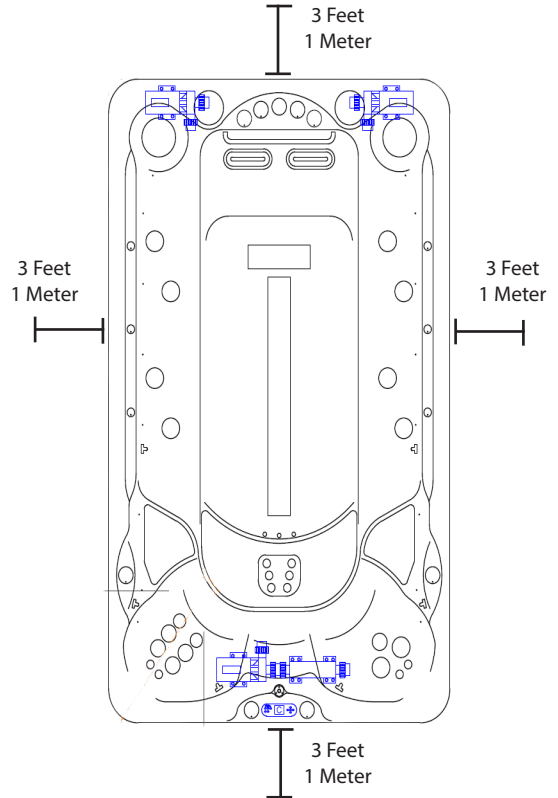

## Preparing a Good Foundation

**Note: We strongly recommend that a qualified, licensed contractor prepare the foundation for your spa. Damage caused by inadequate or improper foundation support is not covered in your warranty. It is the responsibility of the spa owner to provide a proper foundation for the spa.**

Your spa needs a solid and level foundation. The area that it sits on must be able to support the weight of the spa, with water and occupants who use it. If the foundation is inadequate, it may shift or settle after the spa is in place, causing stress that could damage the spa shell and finish. Place the spa on a elevated 3 to 4"/30 cm concrete slab. Pavers, gravel, brick, sand, timbers, or dirt foundations are not adequate to support the spa, if you are installing the spa indoors, pay close attention to the flooring beneath it. Choose flooring that will not be damaged or stained by treated water. if you are installing your spa on an elevated wood deck or other structure, it is highly recommended that you consult a structural engineer or contractor to ensure the structure will support the weight of 150lbs per square foot (732 Kg/m<sup>2</sup>)



## 240 Volt Electrical Installation

Note: These instructions describe the only acceptable electrical wiring procedure. Spas wired in any other way will void your warranty and may result in serious injury. The electrical circuit must be installed by an electrical contractor and approved by a local building or electrical inspector. Failure to comply with state and local codes may result in a fire or personal injury, and will be the sole responsibility of the spa owner.

All 240V spas must be permanently connected (Hard Wired) to the power supply. When installed in the United States, the electrical wiring of the spa must meet the requirements of the NEC 70 and any applicable local, state, and federal codes. The power supplied to the spa must be on a dedicated GFCI protected circuit as required by the NEC 70 with no other appliances or lights sharing the power. Use copper wire with THHN insulation. **DO NOT USE ALUMINUM WIRE.** Copper wire must be used for your GFCI circuit, wires that run over 100 feet must increase the wire gauge to the next lower number. For example: a normal 50 amp GFCI with four #6 AWG Wire must increase wire gauge size to the next lower number, in this example #6 AWG to #4 AWG if the circuit is longer than 100 feet, would require four #4 AWG copper wires.

## Opening the Front Panel For Electrical Access

Cal Spas are designed to withstand multiple climates and different weather across the world. In order to access the control box for electrical hook up, plumbing, or pumps inside of your spa, you may need to remove the corner panels and the front access panel. The following tutorial is designed to illustrate the process of removing/reinstalling any corner panel, and any side panel.

### Caution: Pinch Points.

When snapping panels back into place your spa, be cautious of your hand position. Avoid placing your fingers or hands over the edges of corners or panels, it may result in injury.

**Before starting, make sure you wear gloves when removing any panel from your spa.**



*These instructions describe the procedure to remove your swim spas cabinet panels. The procedure is similar across our family of spas, this procedure on a traditional spa.*

1. First approach what is considered the front of the spa, refer to pages 10-14 to identify where the control box for your spa is placed. You will need this information to identify which panels to remove for electrical access. For spas such as the F-1896DZ the control pack is placed towards the side of the spa.
2. Using a power drill with a Phillips #2 bit, begin to remove screws placed on the panels of the spa that are in front of the control pack. Performing this step with two people is recommended for larger spas such as swim spas due to the size of the panels.
3. Open the spas control box and feed the electrical wires through the opening. Ensure that the electrical wires are not active, with the GFCI Circuit breaker in the off position.
4. Have an electrician/technician properly connect the electrical wires onto the control box. Once properly installed, flip the GFCI breaker.
5. For spas built with electrical conduit passing through the foundation, use the provided drawings or obtain line drawings for your spa model through your dealer or our website.



## Removing Shipping Materials



Your Cal Spa is wrapped with a white shrink wrap designed to protect the acrylic shell from scratches and damage. Thoroughly inspect the plastic wrapping for any tears and or damage that may have occurred during shipping. It is expected to see some scuffs or small tears at the base and corners of the spa, as the spa is pushed and shifted around in transport.

Note: Do not use a box cutter or knife to remove this plastic wrapping, if a blade is used you may cut the plastic wrapping at the bottom base of the spa, avoid slicing near the corners or the top of the spa.



Depending on the type of spa, a piece of wood is placed on the side panels of the spa to protect it in shipping. The wooden supports are installed with several  $\frac{7}{16}$ " (11mm) bolts, once the spa is in its final resting place, remove these with an 11mm socket.

# Pump and Control Box Placement Diagrams

Note: All Spas including swim spas require a minimum of 3 feet clearance on all sides for accessibility for technicians to perform repairs or maintenance. Service providers may charge a fee for poor access which would require movement of the spa by crane or removal of objects/decks obstructing access.

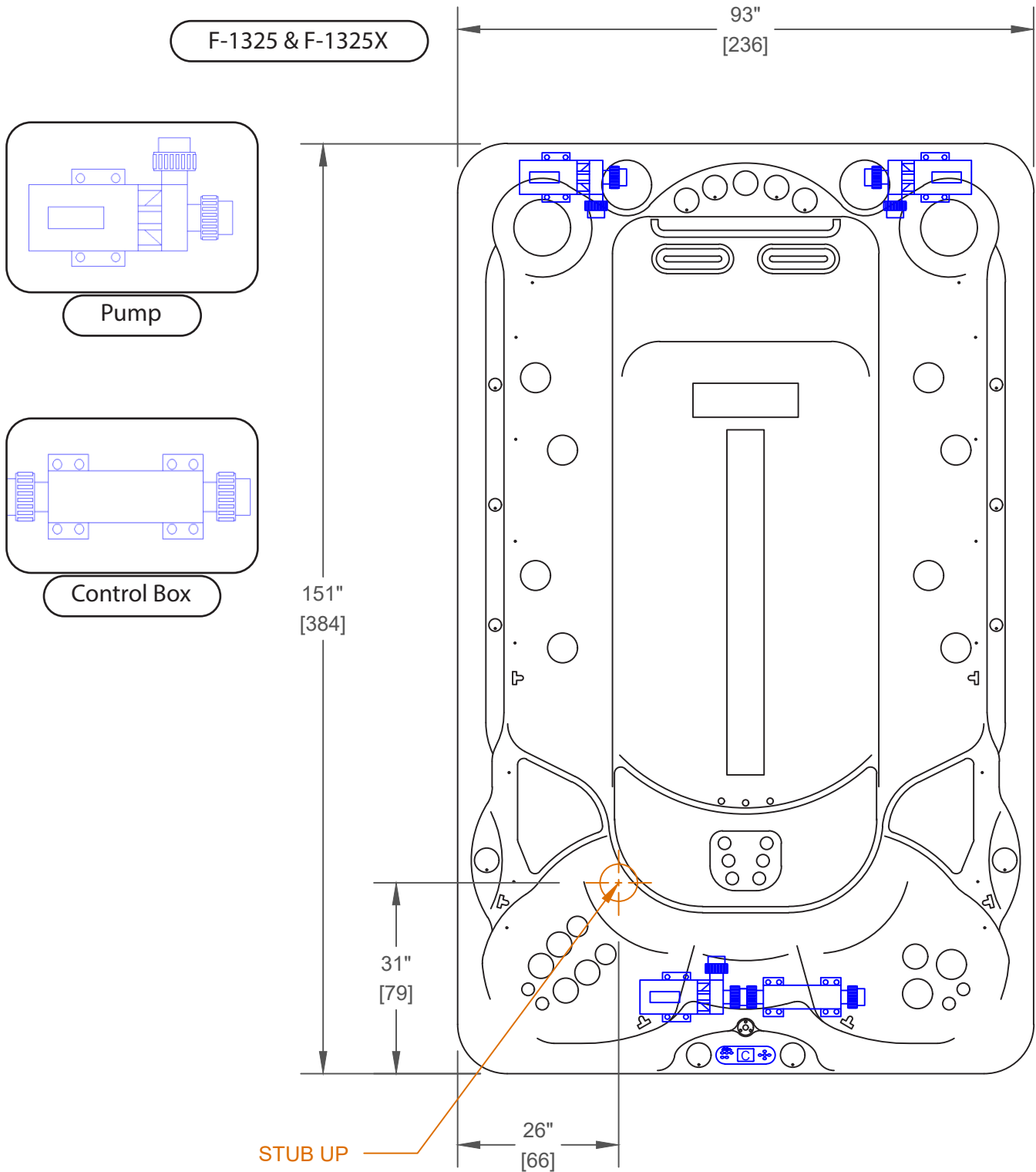

Note: These diagrams are intended to provide a general understanding of where pumps and control box(es) are usually placed. When certain options are selected this may affect final pump placement.

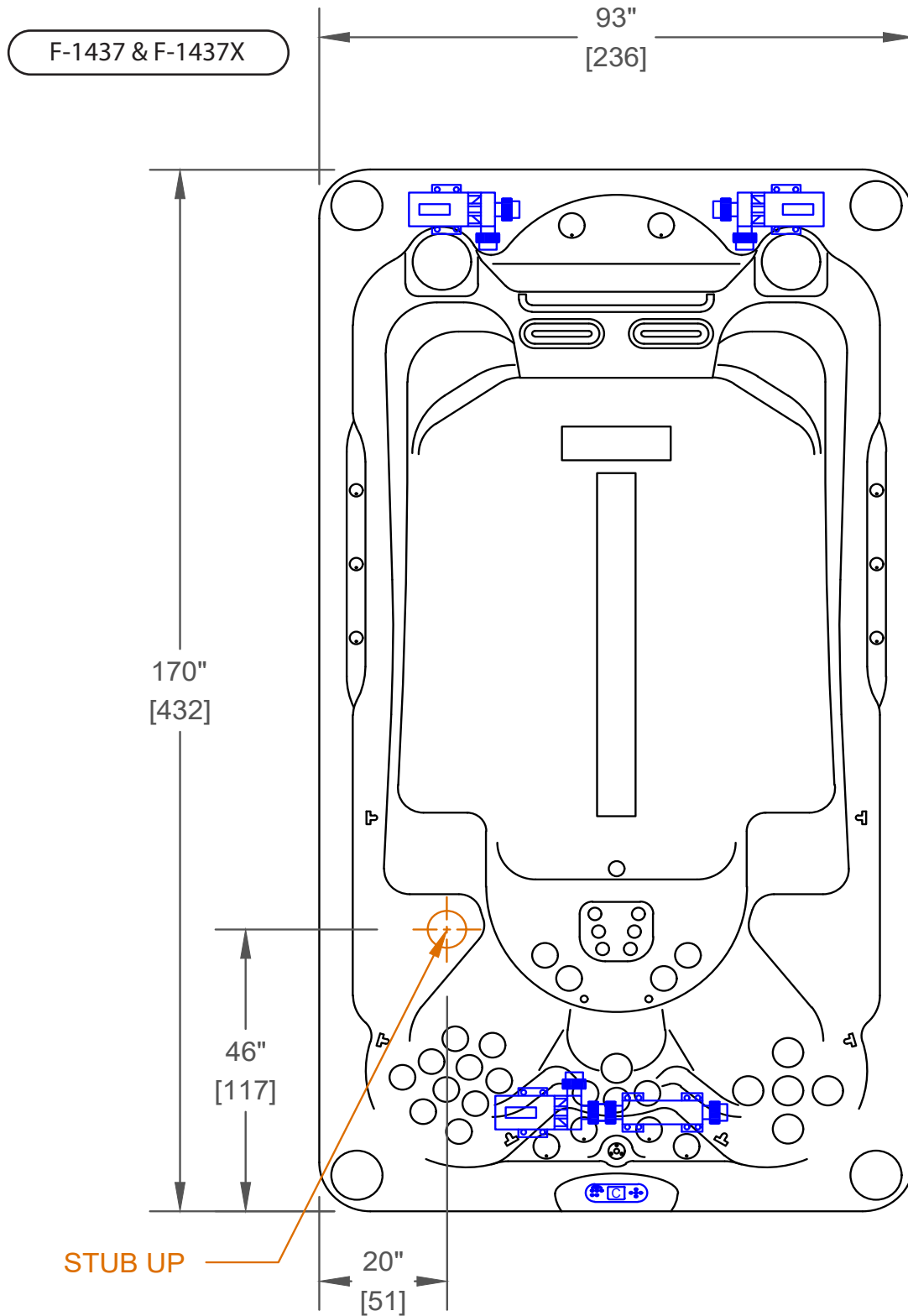

Note: These diagrams are intended to provide a general understanding of where pumps and control box(es) are usually placed. When certain options are selected this may affect final pump placement.

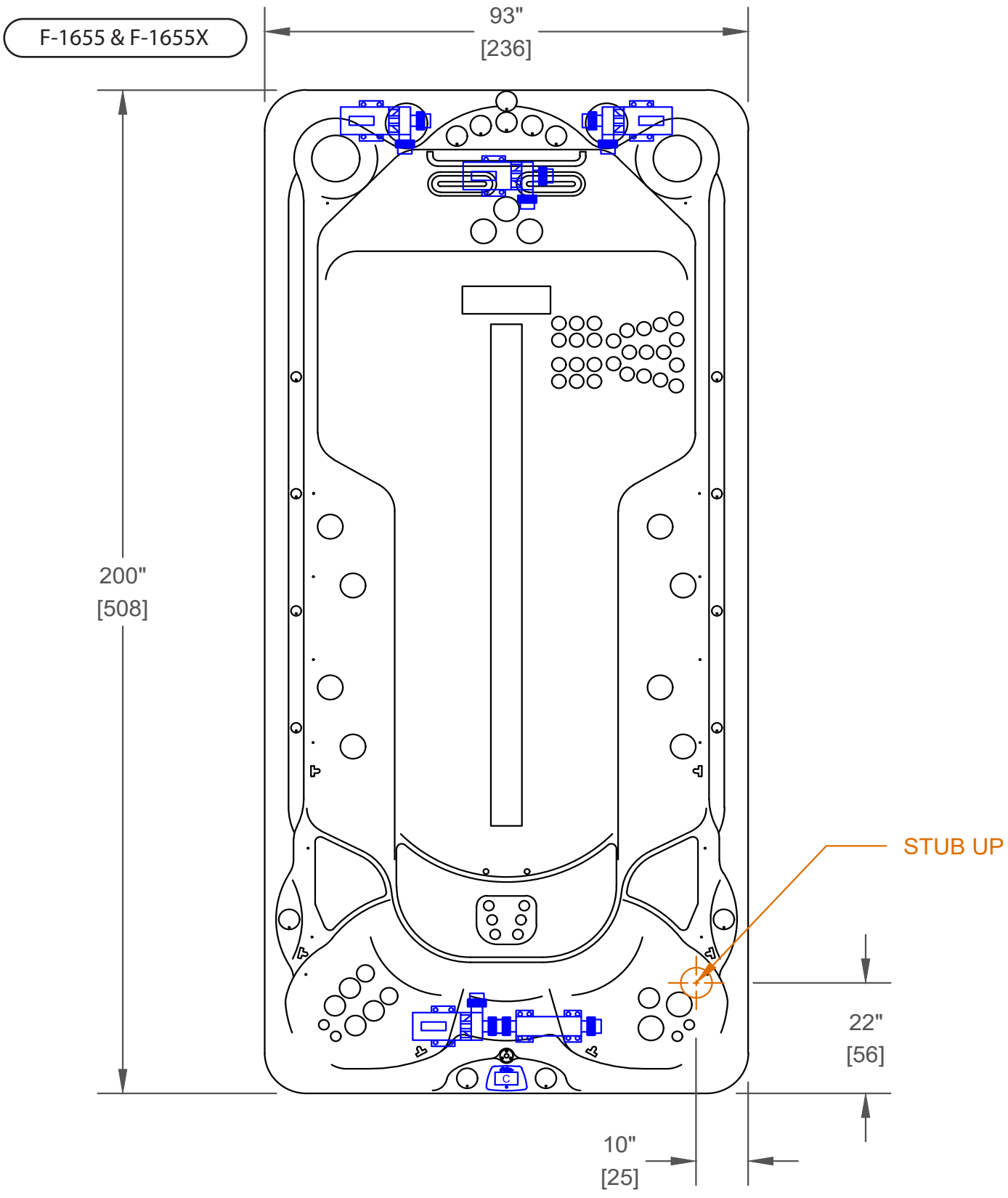

Note: These diagrams are intended to provide a general understanding of where pumps and control box(es) are usually placed. When certain options are selected this may affect final pump placement.

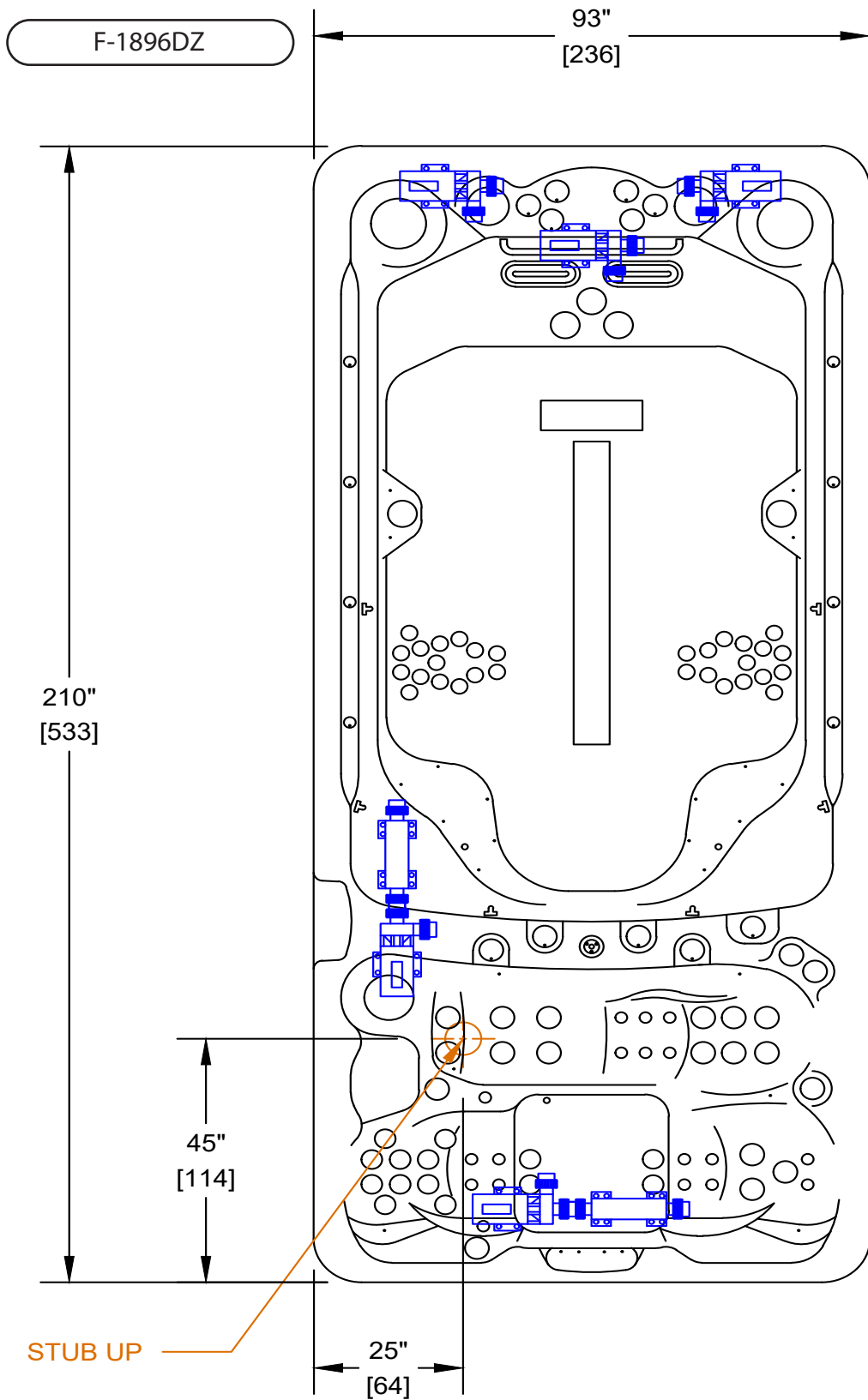

Note: These diagrams are intended to provide a general understanding of where pumps and control box(es) are usually placed. When certain options are selected this may affect final pump placement.

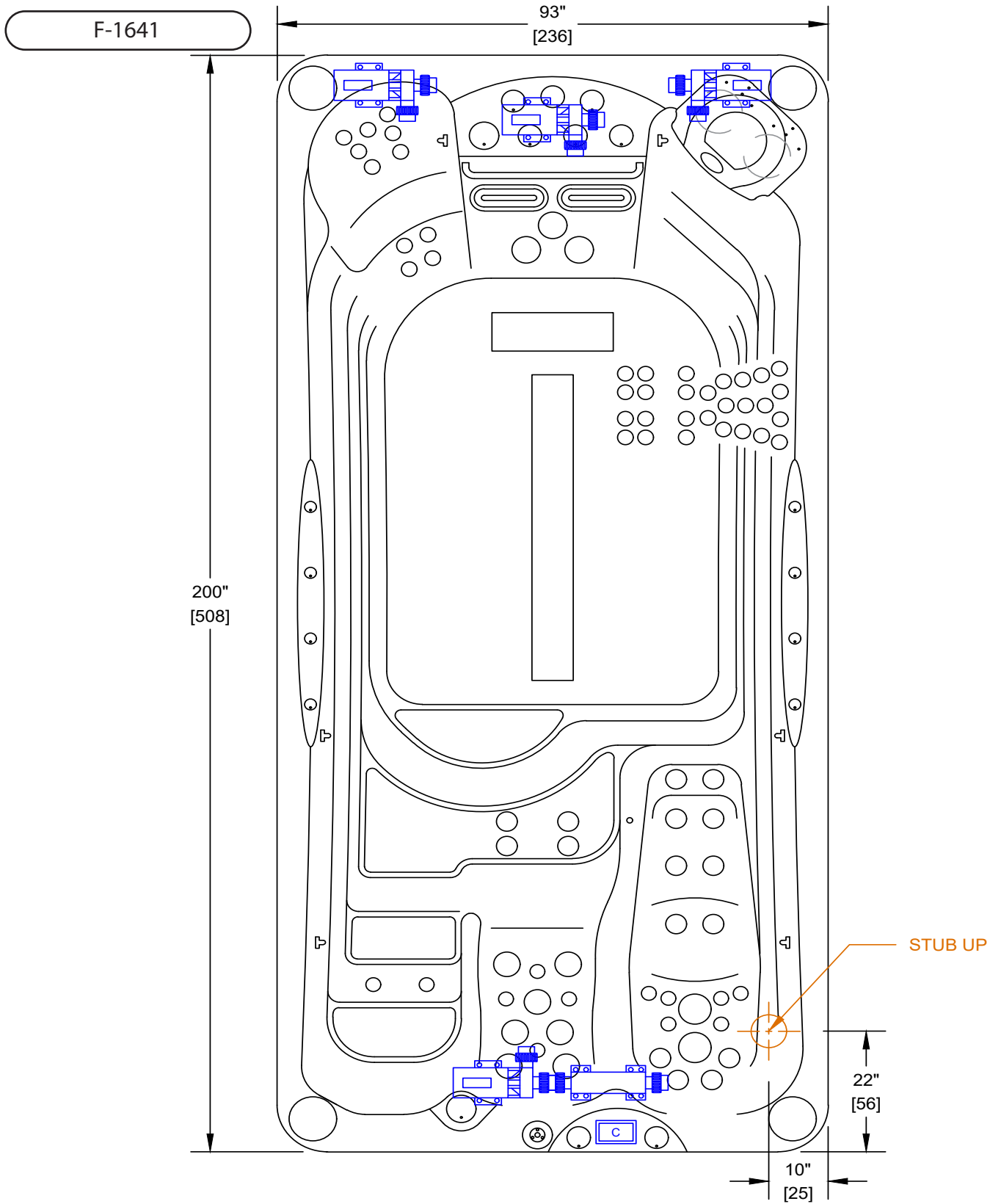

This Page is Intentionally Blank

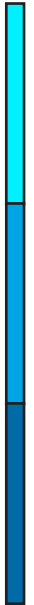

**Wiring Specifications and GFCI Requirement**

Spa Model	Control System	GFCI Breaker	Wires Required
F-1325 / F-1325X	BP501X	One 50 Amp GFCI Breaker	Four #6 AWG Copper Wires
F-1655 / F-1655X	BP20X	One 60 Amp GFCI Breaker	Four #6 AWG Copper Wires
F-1437 / F-1437X	BP501X	One 50 Amp GFCI Breaker	Four #6 AWG Copper Wires
F-1868DZ	BP20X	Service # 1 Swim Side One 60 Amp GFCI Breaker	Four #6 AWG Copper Wires
F-1680	BP501G1	Service # 2 Spa Side 110V 15 Amp Plug & Play	Cord with 15 Amp GFCI Provided



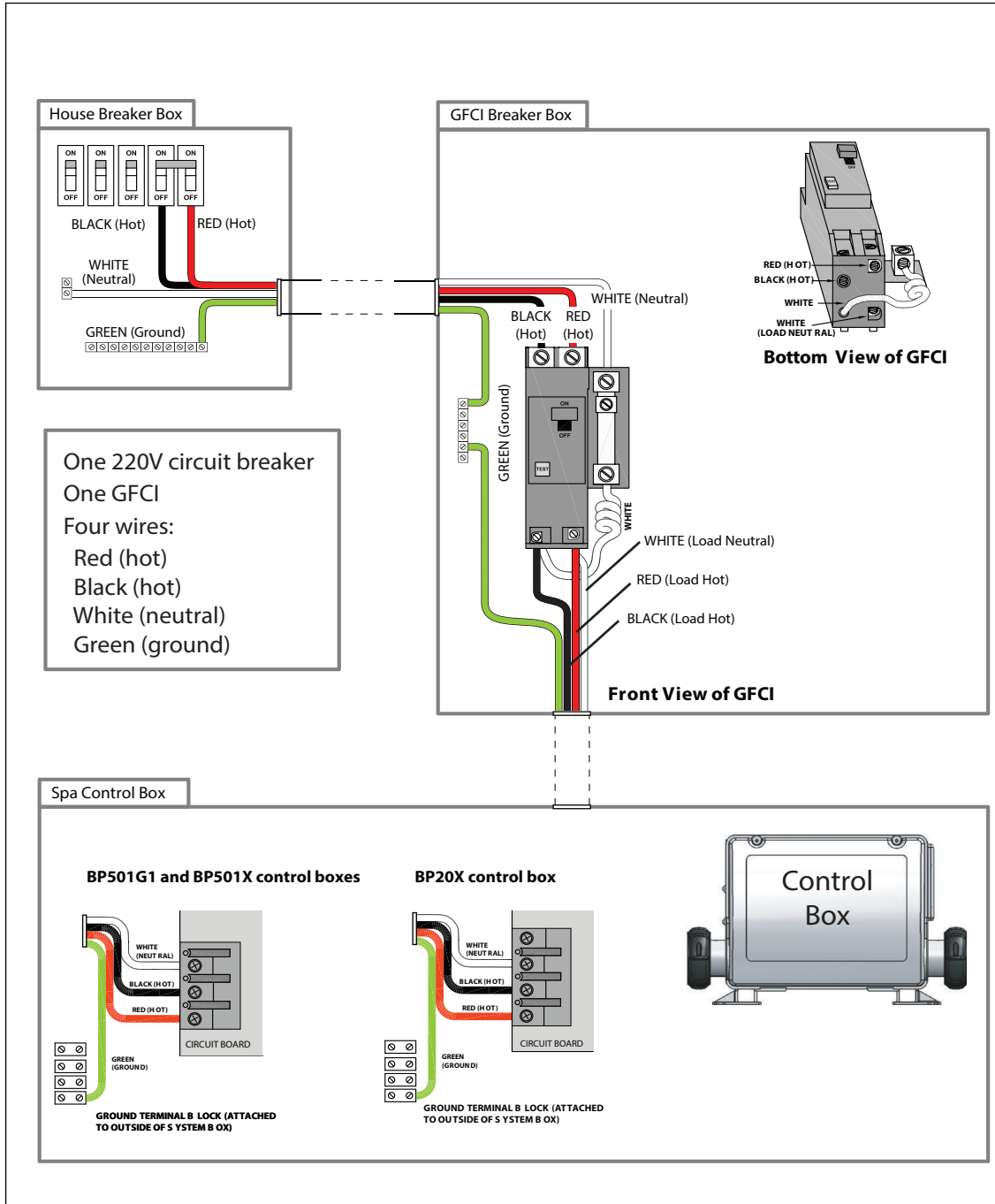

The dual zone Olympian swim spa uses both a 240v GFCI connection as illustrated above and an independent 15 Amp 120v outlet. A total of two separate circuits connecting to the spa.

The spa side of the Olympian uses 120V equipment and uses a built in 15 amp GFCI. The swim side of the Olympian operates on 240V equipment, this circuit must be constructed with a 60 amp GFCI, unlike the 120V side of the spa, the GFCI must be built.

Refer to your local regulations and your certified electrician/contractor for proper installation, follow proper NEC guidelines.

## Filling and Powering Up your Portable Spa

### Step 1. Inspect the Spa Equipment.

Inspect all plumbing connections in the equipment area of your spa.

- Make sure unions connected to the equipment pack are tight (do not over-tighten)
- If your spa has gate valves, make sure they are in the upright position.
- Make sure the drain valve is closed and capped.

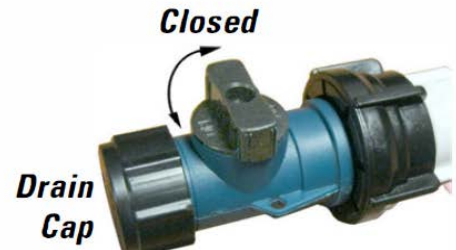
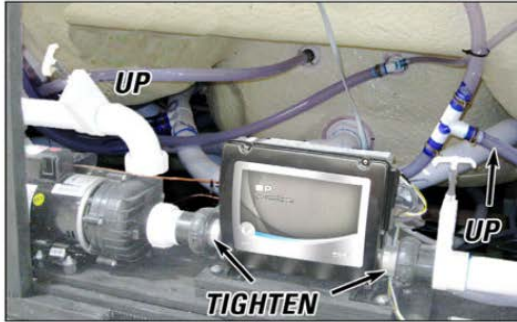

**Note:** Never run the spa with the gate valve closed or without circulating water for long periods of time.

### Step 2. Remove the Filter Cartridge.

If you have a skimmer like this:



#### Teleweir filter skimmer

- 50 square feet filtration
- Spoked cap

Rotate and remove the locking ring (Color may vary). Remove the skimmer cap and barrel, grip the filter by the handle and unscrew it from the canister. Replace and lock the locking ring and slid the skimmer cap and barrel back into the canister. Once the spa is filled you can remove the skimmer cap and barrel again to reinstall the filter.



The skimmer and barrel are locked in place during shipping with a retainer ring. The retainer ring must be unlocked and removed in order to slide the skimmer upward to remove the filter cartridge.



When removing the filter cartridge, you may remove the filter by turning it counter clockwise. The filter must be removed gently to not damage the threaded fitting inside of the filter canister.



After removing the filter, reinstall the retainer ring to the canister, then reinstall the skimmer, this skimmer must be able to move up and down with your water level. In the following step you will fill your spa with water through the filter canister.

**Step 3. Fill the Spa**

Place the water hose inside the filter canister. Fill your spa with regular tap water about six inches from the top. If the water level is too low or too high, your spa will not operate correctly.

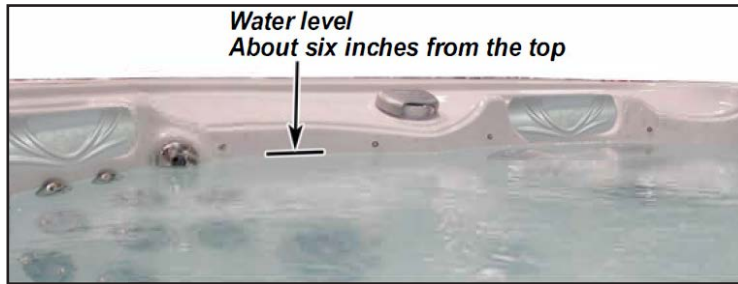

**NOTE: Never fill with soft water.**

Soft water made through some home filtration systems make it impossible to maintain proper water chemistry, and may cause water foaming. This can damage the finish of the spa and void your warranty.

**You may fill your spa with well water, but only if the following preconditions are followed.**

1. Purchase and use a pre-filter that can attach to the end of a hose. This pre-filter is absolutely necessary in order to remove reactive metals and other dissolved solids that are found in well water.
2. Perform a Total Dissolved Solids (TDS) and metals test, this can be performed by a qualified person after filling up the spa, before initial use. Most Dealers and pool supply stores can perform this test.

**Step 4. Power Your Spa**

When the spa is filled to the correct level, turn on the power at the GFCI breaker (ensure that the 120V spas are connected to their dedicated proper electrical outlet.)



**Step 5. Prime the Main Pump**

The system will enter priming mode when powered up for the first time. **Priming Mode** will scroll through the display on the control panel. In this mode all devices including pumps and lights are operable, you may press the jet buttons on and off to help prime the pumps. After a few minutes the system will exit priming mode.

**Step 6.** Install filter into the filter canister

**Note:** Make sure you have removed and soaked the spa filter cartridge in a bucket of water for at least 30 minutes. This will remove air pockets inside of the filter.

When re installing the filter cartridge, do not over tighten the filter, the threaded bit inside of the filter housing is made of a corrosion resistant ABS plastic. Excessive torque will break the internal threads within the filter housing.

**Step 7.** Test and Adjust Water Chemistry

Test and adjust the water chemistry.

**Step 8.** Let the Spa Heat Up

After a period of 5-15 minutes the priming mode will finish. The heater will then activate, put the spa cover on and let the spa heat to the desired set temperature.

During the initial power up the spa, it will consume a large amount of energy to raise the water in the tub to your desired hot tub temperature. Cal Spas are designed for high efficiency, once the temperature within the spa is reached, the spa will use lower amounts of energy to maintain the temperature.

**Note:** Cal Spas are designed to retain heat, if it is desired to lower the water temperature the spa does not contain a cooling feature. To lower internal temperature of the spa, lower the set temperature on the control panel and open the tub during the evening or night to help release the heat captured within. You may also drain 1/4 of the water within and refill with new water to lower temperatures rapidly.

New owners often have difficulty the first time they start their spa and the pumps fail to prime. This can be frustrating but these instructions should help you resolve any issues with air pockets inside of the primary pump or other priming issues.

Sometimes air can become trapped in the primary pump while filling up the spa, although this should be preventable by filling your spa through the filter basket, there is a chance that an air pocket can still form even when following the proper steps. Initially it may seem that the pump is not working, with some sound coming from the pump but no water movement.

**Note: When a pump has an airlock, continuing to operate the pump experiencing an air pocket issue can damage the pump. Do not operate the pump until this airlock issue is fixed.**

### Start Up: Priming Mode

When the spa is powered up for the first time, the spa will enter priming mode. During this mode all devices within the spa is operational. You may wait for 10-15 minutes for the heater to engage, this period of time resets when a secondary pump is activated or if the primary pump is activated for high speed.

**The spa will automatically exit priming mode.**

### Bleeding Air from the Pump

IF you have tried priming the pump by pressing the jet or jet 1 button on and off again with no results, you will need to bleed the pump manually.

1. Shut off power to the spa.
2. Using a philips head screwdriver, remove the front panel from the spa directly underneath the control panel, and locate the main pump.
3. Ensure that the gate valves are open
4. Place rags or towels under the plastic wet end of the pump where the spa plumbing connects into the pump
5. On the plastic wet end there will be a plastic hex headed bleeder valve that can be opened to bleed air trapped inside of the pump
6. Do not fully remove the nut, there are grooves within the nut that allows air to escape. Water will begin to trickle once the air pocket has been removed, tighten down the screw again with light torque.
7. If bleeding the pump is unsuccessful, loosen the pump unions with plumbing channel locks to remove any trapped air between the pump and the heater.
8. Turn the spa power back on and press the Jet button to prime the pump again.

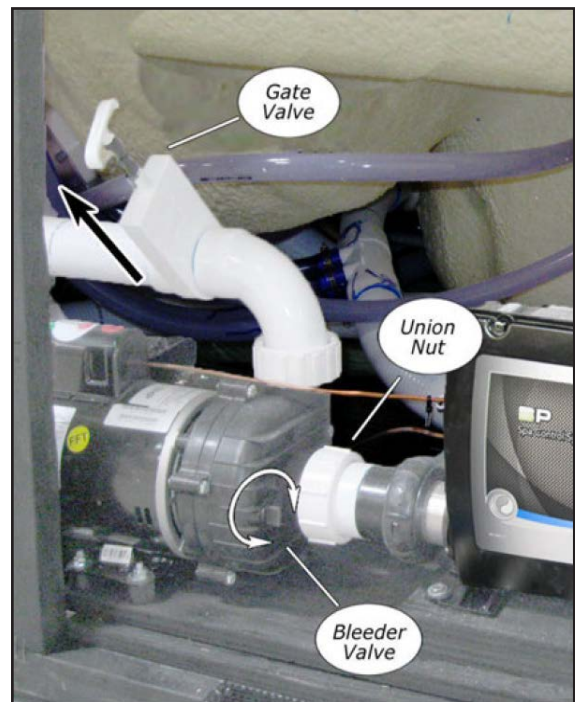

## Spa Touch 2 Control Panel



### Spa Touch Control System

Certain Cal Spa models are offered with an upgraded control panel, the Spa Touch 2 control system. The elegant 4 1/2" touch display offers easy navigation of all of your spas equipment, with an elegant color LCD screen. The controllers main screen is designed display all main equipment options, including temperature control, LED light activation, and pump activation. There is easy access to your spas internal settings for filtration, time/date, heat modes, languages, and other specified features.

The top of the display is designed to offer insight on what operations or modes are activated inside of your spa. Ensuring that you know everything and anything your spa is doing at that very moment.

### Display Care

To maintain and care for your spa display, we recommend using a microfiber towel to clean the display from finger prints. The touch screen is designed to respond to touch with wet hands, but excessive water droplets on the display should be wiped away with your hand before using the controller.

## Olympian F-1868DZ Spa Controls

The Olympian F-1868DZ, a dual zone spa that combines your work out, with your relaxation. The swim spa is designed with a spa partition that fits three adults. This segment of the spa is controlled by an independent balboa control system, using the Spa Touch 2 display. The following pages are to help you navigate through settings and controls within the spa side of the Olympian.

# The Main Screen

\*With Wifi Module

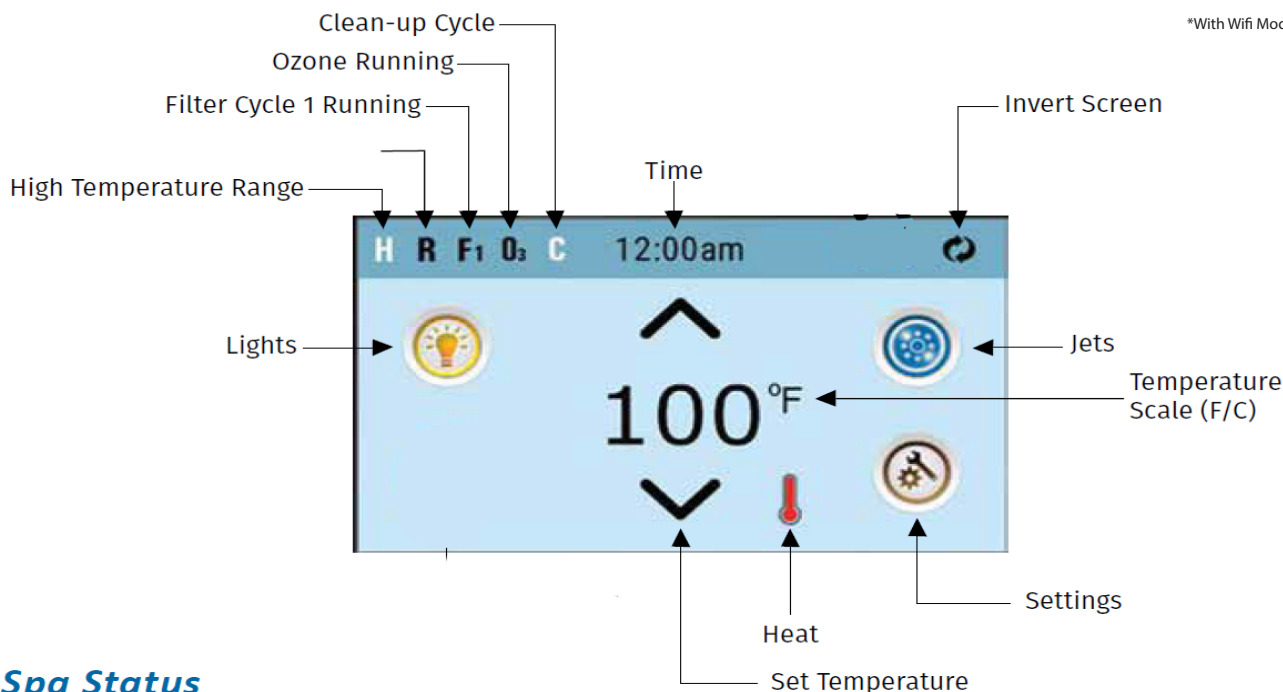

## Spa Status

Important information can be found on the main screen, such as temperature adjustment, current spa operations, pump activation, lights, and the settings tab. Certain icons or options may not appear on your display, this dependent on the options your spa is equipped with.

- H = High Temperature Range
- L = Low Temperature Range

- R = Ready Mode | RR = Ready/Rest Mode
- = Rest Mode

- F1 = Filter Cycle 1 is running
- F2 = Filter Cycle 2 is running
- F+ = Filter Cycles 1 & 2 are both running

- O<sub>3</sub> = Ozone is running. If you don't see the icon that means the Ozone is OFF.

- C = Clean-up cycle is running.  
Note: Not all systems that can run a Cleanup Cycle display this icon.

- Wi-Fi icon just indicates that the Wi-Fi link is connected.

- = Invert (or flip) Screen

- = Adjust set temperature higher

- = Spa equipment control icon  
Brings up a screen where the spa jets, blower or other equipment can be controlled. While on the Spa Equipment Screen, you can press a Jets button once for low speed, and if configured press it again for high speed.



- = Jet is inactive. Indicates if a pump is running or not

Current water temperature if °F or °C is solid  
Set temperature if °F or °C is flashing

- = Settings is active = Settings is inactive  
(when the panel is locked). Takes you to Settings Screen

- Different animation sequences, including blinking, may indicate different stages of heating

● ∨ = Adjust set temperature lower

●  = on  = inactive  = disabled

●  = on  = inactive  = disabled

● Message waiting indicator: The Message Waiting Indicator will show one of the following icons:

 = fatal error (Spa can't function until it's fixed)

 = Normal Error or Warning

 = Reminder Message

 = Information Message

## NAVIGATION



Music



Settings



Spa Equipment

## MESSAGES



This icon indicates that a message is waiting for you to review, it can be an error code or a general message code.

After 30 seconds the display will enter sleep mode and power off, you can tap the display to wake up.

### Adjusting Temperature

You can press the up and down arrows once to see what the spas set temperature is, this is shown by the temperature values changing in color to indicate the set temperature. Pressing the up or down arrows again will move the set temperature to whatever temperature you desire. You may also press and hold the arrows to change temperature.

*Note: if the spas set temperature was 99°F, and you set the new temperature to a lower value for example 94°F, the spa will not chill and cool down. This change in value commands your spa heater to only activate to maintain 94°F. The heater will remain off until the water temperature falls below 94°F, in order to maintain the new set temperature.*

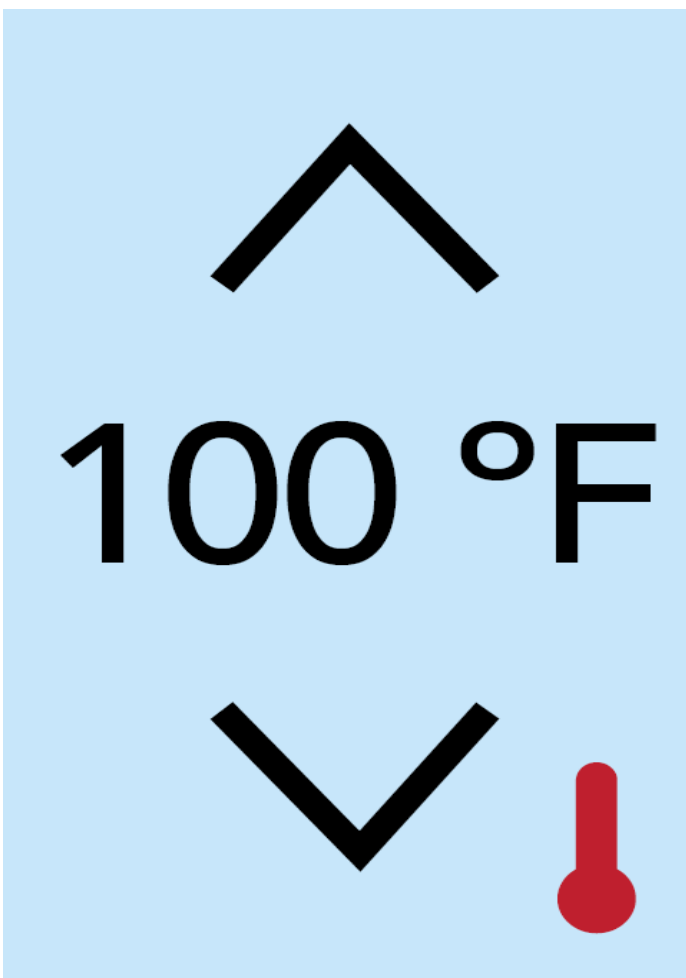





**Step 1.** Touch the Settings Icon at the lower right portion of the screen.

 Appuyez sur l'icône Paramètres dans la partie inférieure droite de l'écran.

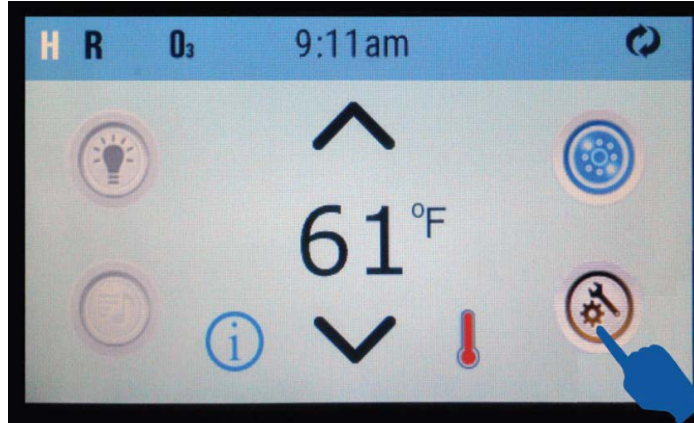
 Toque el ícono de Configuración en la parte inferior derecha de la pantalla.



**Step 2.** Touch the right arrow icon at the lower right portion of the screen. Pressing this allows you to navigate to the next screen

 Appuyez sur l'icône de flèche droite dans la partie inférieure droite de l'écran. En appuyant dessus, vous pouvez accéder à l'écran suivant

 Toque el ícono de flecha derecha en la parte inferior derecha de la pantalla. Al presionar esto, podrá navegar a la siguiente pantalla.

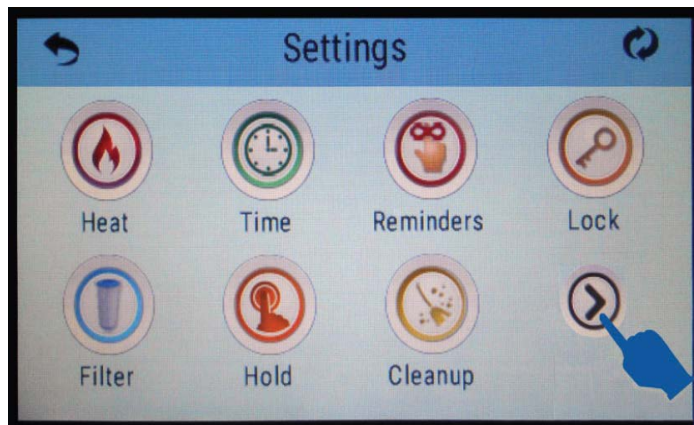



**Step 3.** Touch the Language icon

 Appuyez sur l'icône Langue

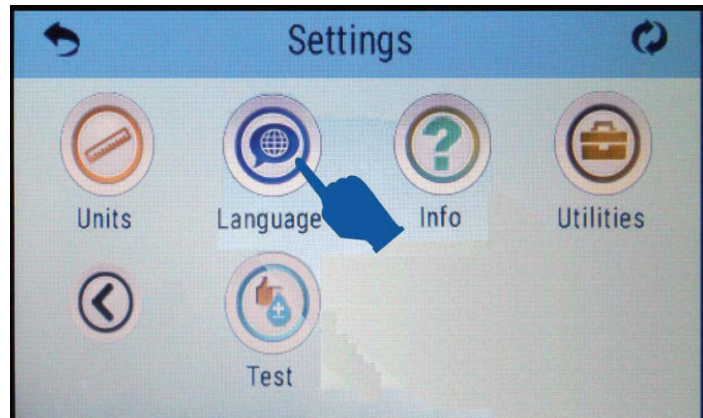
 Toca el ícono de Idioma





Once you select the language icon, the screen will open up a list of languages you can select, use the up and down arrows to navigate down the list of available languages.

  Une fois que vous avez sélectionné l'icône de langue, l'écran ouvrira une liste de langues que vous pouvez sélectionner, utilisez les flèches haut et bas pour parcourir la liste des langues disponibles.

 Una vez que seleccione el ícono de idioma, la pantalla abrirá una lista de idiomas que puede seleccionar, use las flechas hacia arriba y hacia abajo para navegar hacia abajo en la lista de idiomas disponibles

**Step 4.** Select your language of choice, we will select Spanish as an example.

  Sélectionnez la langue de votre choix, nous sélectionnerons l'espagnol comme exemple.

 Seleccione su idioma de preferencia, seleccionaremos español como ejemplo.

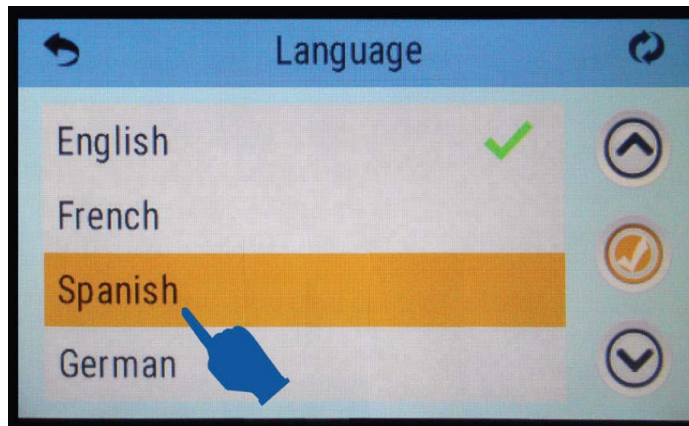

**Step 5.** The screen will refresh and your selected language of choice should now be the default setting.

  L'écran s'actualisera et la langue sélectionnée devrait maintenant être le paramètre par défaut.

 La pantalla se actualizará y el idioma seleccionado ahora debería ser la configuración predeterminada.

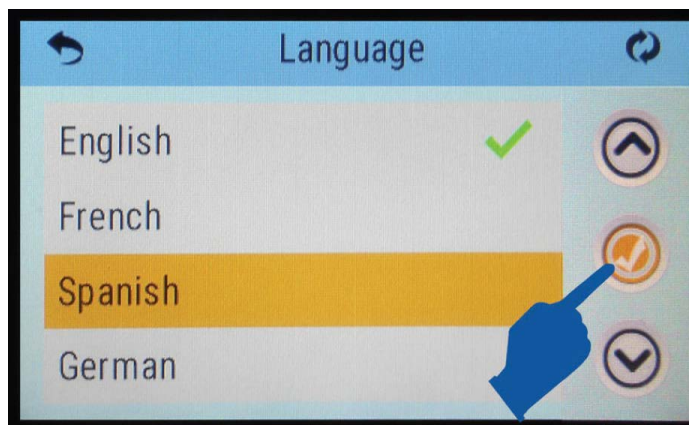

### Priming Mode [Initial Start Up]

When your spa is first powered on the unit will enter a mode called priming mode, this also occurs whenever the power to the unit is cut off from a GFCI trip or a power surge. This modes purpose it to ensure the primary pump is clear of any air pockets or obstructions, and allows your temperature sensors to calibrate and read the water temperature to begin the heating process or to disengage the heater if the spa is already within its desired range.

When Priming Mode starts, the primary pump will turn on in low speed, then switch to high speed. This is done to purge any air pockets, that could have been trapped inside of the pump. This is considered normal operation. Priming mode will run for about 4-5 minutes, the spa will enter regular heating and filtering once Priming Mode ends. You can manually exit priming mode by pressing the "Back" icon on the priming mode screen.

*Note: if after 2 minutes you see no water movement or hear the pump activating but no visible or notable water movement, cut the power to the spa from the GFCI and read the pump bleeding procedure in the beginning of this owners manual. A large air pocket within the pump could be causing issues with water circulation. Following the pump bleeding procedure, activate the spa power again. If there is no water movement within the spa, call your dealer for service as there could be an issue with your primary pump or control box.*

### Temperature Sensors



When priming mode occurs, this allows time for the water temperature sensors inside of the control box to gather data and display the correct temperature. During priming mode or when you skip/exit priming mode, the sensors may show no values on its temperature reading. This is normal as it is collecting data through a period of time, to give an accurate reading. It usually takes about 1 minute of data collection for the display to properly display the temperature.

### Freeze Protection

To prevent water freezing inside of the spa water lines and pumps, the sensors will detect drops in water temperature inside of the spa. The pump(s) will purge and run on max speed to circulate water inside of the spa to prevent the creation of ice. During cold/freezing weather it is recommended to keep the spa around 80F, filled up, and operating during the colder months. The insulation inside of the spa and the spa cover, will help retain heat inside of the spa. Although you can follow the winterization procedure inside of this manual, this does not guarantee against ice damage inside of the spa.

**Pumps will run continuously or intermittently depending on the conditions and ambient temperature.**

### Ozonators

If your spa is equipped with an ozone generator, the ozone generator will operate during filtration cycles. Ozone generators help breakdown organic materials suspended inside of spa water, reducing odors and assists your sanitizers effectiveness.



*Pump Speed Indicator*



Fig. 1-01

The spa screen shows all available equipment to control based on your spa options. The icons shown in this screen may vary based on the number of pumps or additional options the spa is equipped/ordered with.

Some pumps have more than one speed, indicated by Figure 1-01, some spas have only one dual speed pump, and others can be equipped with one dual speed pump with additional single speed pumps.

If your spa was equipped with a circulation pump (24hr filtration system), the spa control screen will show if the circulation pump is active, but this pump will not be able to be controlled through the panel.

**Navigation and Selection**

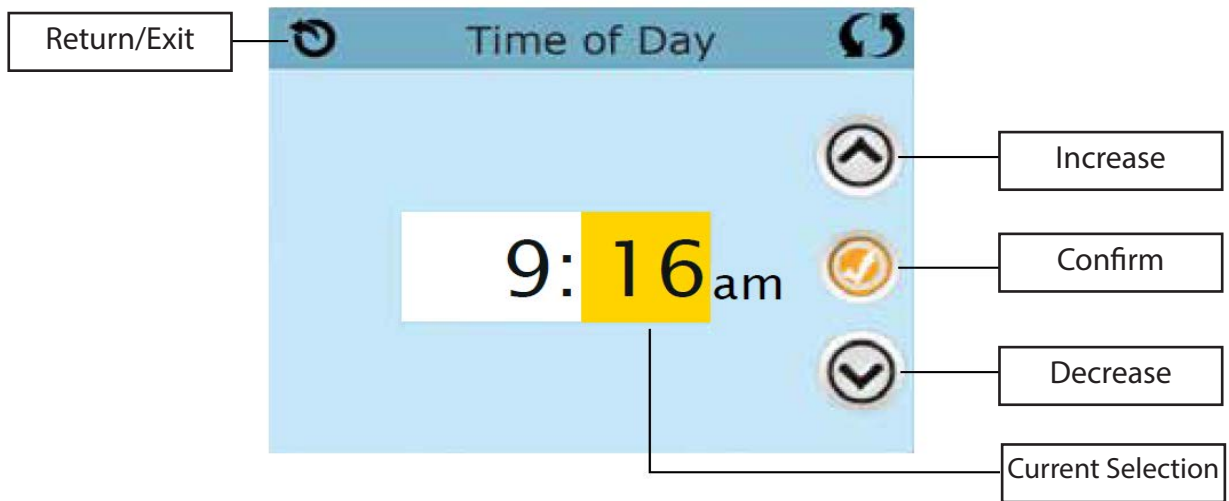

As you navigate through screens you can confirm what options are active or inactive by looking at the small check-mark icons within the selected page.



**Active Save Button**



**Inactive Save Button**

# Navigation Between Pages

**Page Left | Page Right** : Certain menus contain more than one page to access all options. Use the navigation arrows as illustrated bellow to move page to page



Next Page

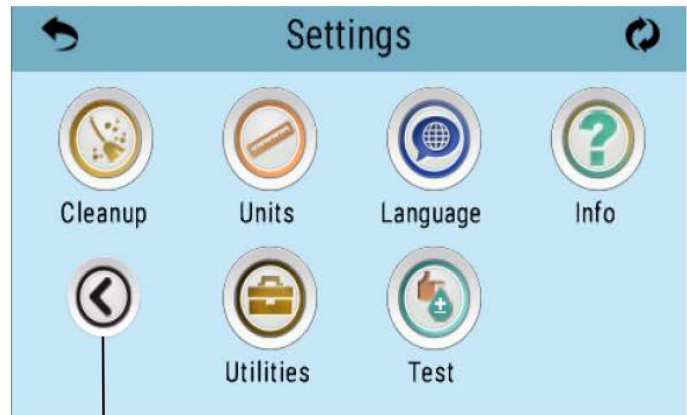

Previous Page

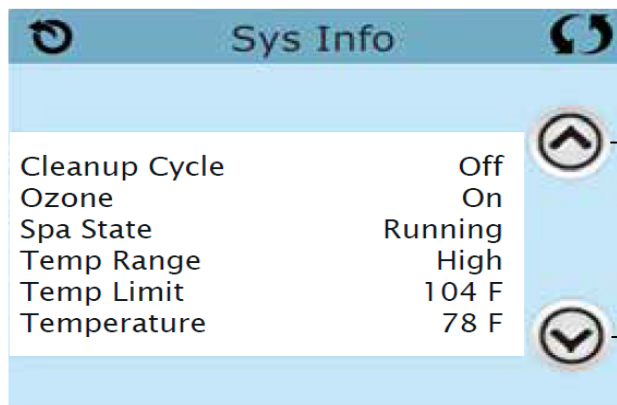

Line/Page Up

Line/Page Down

Similarly you will press these arrows to navigate up and down.

Depending on the screen these arrow icons can be used to change values or to navigate through the screen.

# The Settings Screen

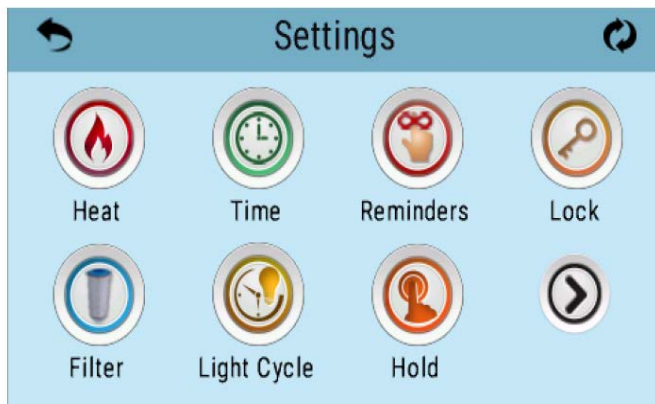

The settings screen is where all programming and certain spa operations are controlled. Each Icon leads to a sub menu that can toggle specific parameters that fall under the mentioned option.

### Dual Temperature Ranges

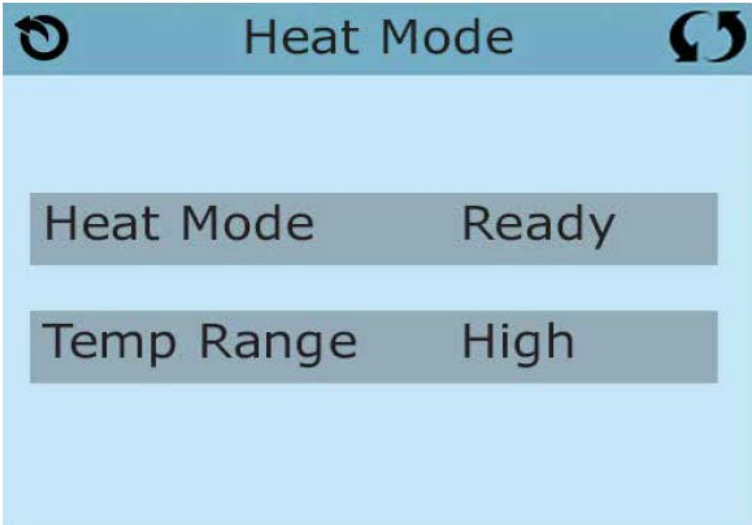

By pressing the 🔥 icon you will be able to access and control the heat range and heat mode of your spa.

#### Heat Modes:

Your spas heating system activates whenever the temperature falls below the set spa temperature, this is called "Ready" Mode.

To maximize energy efficiency and lower costs most spa owners will run high power demand operations such as filtration cycles in the evening or night, when energy costs are lower. You can also set the spas heater to only activate during its filtration cycle, this is called "Rest" Mode.

### Ready in Rest Mode

In some spa models when the spa is programmed for rest mode and a jet button is pressed, the heater will kick on automatically. The heater will run for about 1 hour after a jet or pump is activated to maintain the heat of the spa while it is in use. Ideally its best to run a 3-4hr filter cycle at night when energy costs are lowest, allowing enough time for the spa to heat up during its filtration. This allows Ready in Rest mode to accommodate for small drops in temperature throughout the day.

*Note: Always use your insulated spa cover to maintain the temperature within your spa.*

### Setting the Time of Day

It is important to set the time within your spa control system. Setting the proper time within your spa allows you to have better control of your filtration system and accurate reminder notifications. As long as the power to the spa remains active, the internal clock will display the correct time. Keep in mind that the spas control system does not account for daylight savings time, and will need to be manually adjusted.

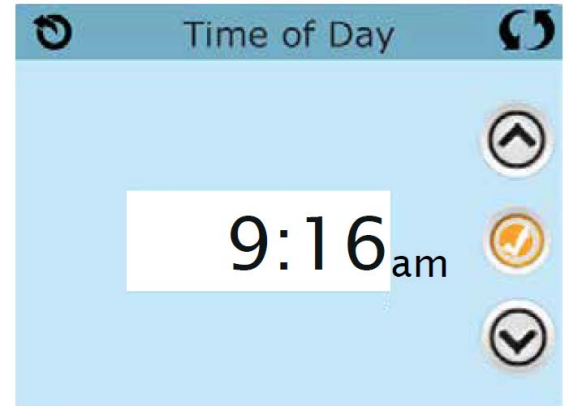

### Message Code: 40

Whenever the power to your spa is interrupted or an electrical fault occurs, the internal clock will reset. This error also occurs when the spa is powered on for the first time.

### Adjusting Filtration

Filter Cycles are very important in maintaining water clarity within your spa. Each setting can be adjusted by increments of 15 minutes. Most spa owners are able to maintain water clarity with a total of 3-4 hours of filtration per day. Your spa is able to have two separate filter cycle times based on your spa usage. By default filtration 1 is active, you can activate the second cycle by tapping the "2" icon and setting a time, confirmed with the checkmark on the right side of the screen. To maintain optimal filtration, make sure you perform regular maintenance on your filter cartridge. **Systems with a 24hr circ pump must set the start time from 12pm to 12am to activate the circ pump features.**

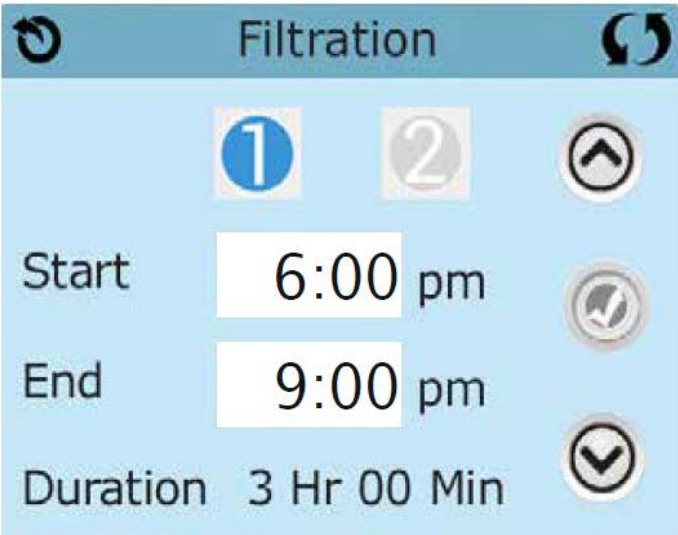
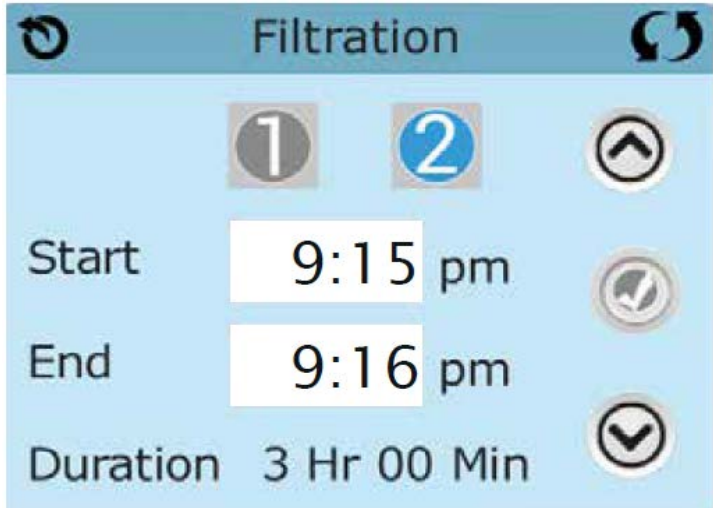

Viewing Filter 1 while Filter 2 is OFF:

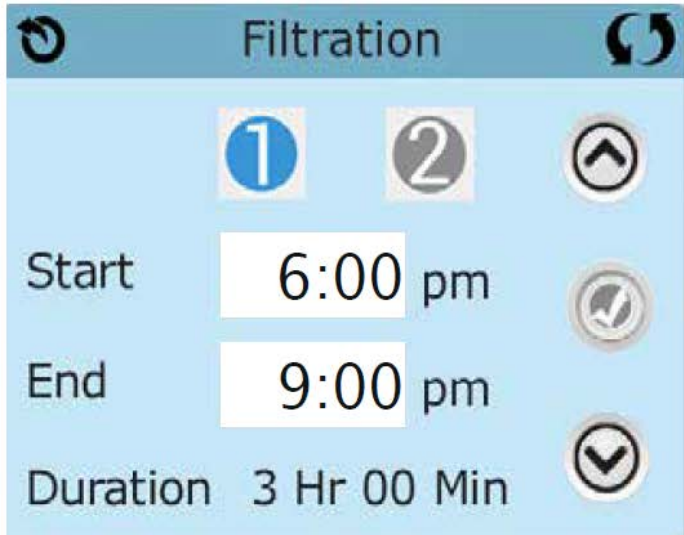

Viewing Filter 1 while Filter 2 is ON:

### Panel Locking/Unlocking

You can restrict panel operation to prevent unwanted modifications to your spa settings, or spa operation. To lock either the panel or the settings select the settings tab, and press the "Lock" icon. The panel will show two icons, representing panel and settings. You may choose which kind of restrictions you want to activate. locking settings will restrict access to the spas settings, activating panel lock will restrict all spa panel operations. If you wish to unlock the display, place your finger on the top where the words "Lock" appear, hold your finger for about 5 seconds and the panel will unlock to its regular operations.

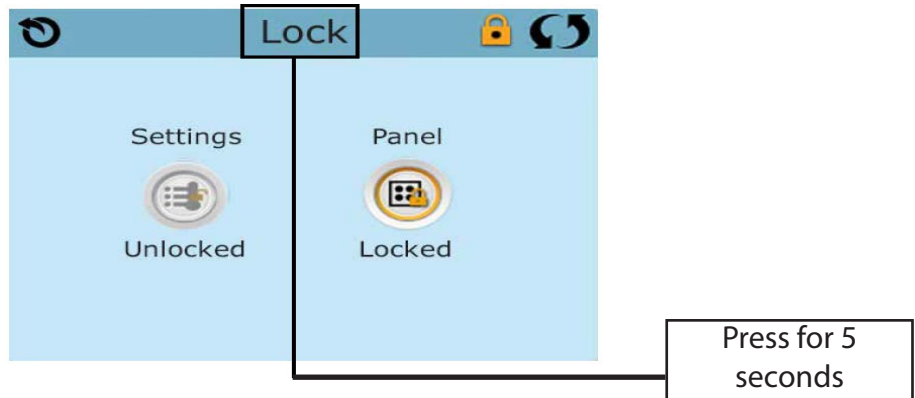

## Utilities

The Utilities icon  on the settings screen will take you to the Utilities screen. This screen contains several options that can modify the operation of the touch panel, as well as testing tools and the spa fault logs.

### Panel

Selecting the Panel icon allows you to choose the duration of time that the control panel remains activated before entering back into sleep mode. The display can remain active between an interval of 1 min to 60 min.

### Demo Mode

Demo Mode is not always active, so it may not appear, this mode is designed to operate several spa features/devices in sequence. This mode is intended to showcase the various features of the spa.

### Fault Log

The spas control system has an internal memory to keep track of any fault codes or messages that are generated. The fault log stores the last 24 error codes generated by the system. This includes normal operation codes and actual fault codes. For example “Priming Mode” will appear in the fault log but it is not a fault, it is a code that is used to keep track of when the spa restarts. Having codes like this appear in the fault log allows for better troubleshooting, by allowing technicians to see the spas entire code history to observe normal spa operations.

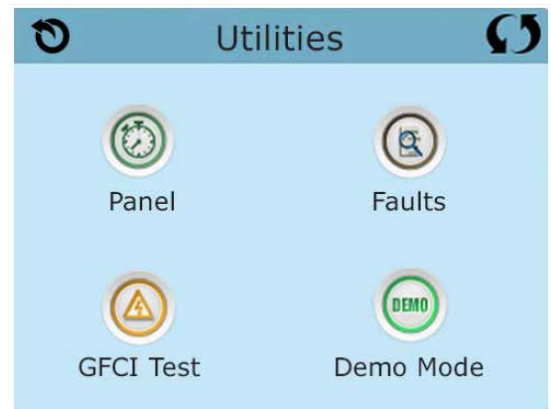

### GFCI Test

This feature only exists with models sold in North America.

You are able to test the GFCI circuit connected to your spa through this feature to ensure that your GFCI is properly grounded and able to handle a surge or ground failure.

- Manual GFCI Test is enabled in this system
- GFCI test will not appear on your screen if its not enabled, with 120V systems this feature may not be enabled since there is a tested physical GFCI connected to 120V spas.



## Additional Settings

### Units

The units screen allows you to change the units of the display from either imperial inches or Metric

### Reminders

The reminders icon takes you to the reminders screen. Choosing to have reminders activated will allow you to get maintenance reminders on the display of your spa. This can range from reminders to perform filter maintenance or to remind you to change the spa water if needed. These reminders are based off of common water intervals, some reminders may recommend a task that may not be necessary based on your spa usage.

*Note: The only way to properly maintain your spa is by regular maintenance and spa water testing.*

### Clean Up Cycle

Your spa will start a clean up cycle every time after you activate the pump or spa lights. The duration of the clean up cycle can be changed based on your spa usage. For example the spa normally performs a 30 minute clean up cycle after use, if you tend to use this spa with a heavy bather load (more than 2 people), it would be a good idea to increase the amount of time the clean up cycle operates for.

**You may also disable this feature by setting the time to 0.0**



# General Messages & Heater-Related Messages

## Water is too hot - M029

The system has detected water temp of 110°F (43.3°C) or more, spa functions are disabled. The system will auto reset when the spa water temp is below 108°F (42.2°C). Check for extended pump operation or high ambient temp.

## Water flow is low - M016

There may not be enough water flow through the heater to carry the heat away from the heating element. Heater will attempt to start up again after 1 minute. Correct any water flow restrictions.

## Water flow has failed - M017

There is not enough water flow through the heater to carry the heat away from the heating element and the heater has been disabled. After the problem has been resolved, reset the message.

## The heater may be dry - M028

Possible dry heater, or not enough water in the heater to start it. Shut down the spa for 15 min to reset this message. Call for service if this message does not clear, as there could be an issue with your sensors or your spa pumps.

## The heater is dry - M027

There is not enough water in the heater to start it. The spa is shut down. After the problem has been resolved, you must reset the message\* to restart heater start up.

## The heater is too hot - M030

This code occurs when, one of the water temp sensors has detected 118°F (47.8°C) in the heater. When this happens the spas current operations will shut down. You must reset the message, and this message will not reappear, when the water in the heater is below 108°F (42.2°C).

# Sensor-Related Messages

## Sensors are out of sync - M015

When this error code appears, the temperature sensors may be out of sync by 3°F. Call your dealer for service, if this message does not disappear within a few minutes.

## Sensors are out of sync - M026

This code is specific to when the system has detected a consistent temperature difference between the sensors of 3°F or more. Contact your spa dealer for service.

## Sensor A/B Fault - M031/M032

Either temperature sensor A, B, or both have failed due to a circuit failure. Call your spa dealer for service.

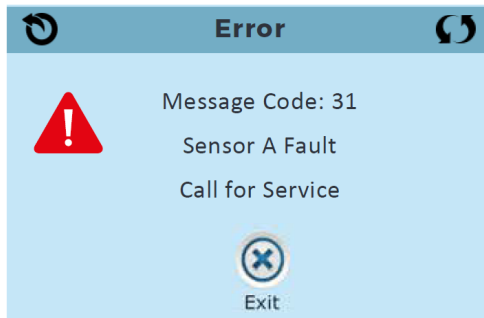

# Sensor-Related Messages

## Communications Error

The control panel is not receiving communications from the control system, call your spa dealer for service.

## Test software installed

The control system is operating with test software. Contact your spa dealer for service or to reformat the unit.

# System-Related Messages

## Settings have been reset - M021

Contact of spa dealer if this message appears on more than one power up. This could be an internal memory issue.

## The clock has failed - M020

The internal clock in your control system has failed. Contact your spa dealer for service.

## GFCI Test has failed - M036

Indicates the failure of an automated GFCI self test. This highlights a possible issue with your spas GFCI electrical circuit.

## A pump may be stuck on M034

Indicates the failure of an automated GFCI self test. This highlights a possible issue with your spas GFCI electrical circuit.

## Hot fault - M035

A pump is possibly in a stuck on position when the spa was last powered on. Meaning the electrical switch controlling the pump is stuck in the on position, ignoring the switch off command. **DO NOT ENTER THE SPA, DO NOT ENTER THE WATER.** Contact your spa dealer for service.

# Reminder Messages

## Check the PH

May appear on a regular schedule, i.e. every 7 days. Check pH with a test kit and adjust pH with the appropriate chemicals.

## Check the sanitizer

May appear on a regular schedule, i.e. every 7 days. Check sanitizer level and other water chemistry with a test kit and adjust with the appropriate chemicals.

## Clean the filter

May appear on a regular schedule every 30 days. Rinse the filter cartridge out and gently reinstall.

## Test the GFCI

May appear every 30 days. The GFCI is an important safety device that should be tested to verify its reliability.

## Change the water

May appear every 90 days. A general recommendation of draining the spa and using new water to ensure water clarity and proper sanitation. This interval is dependent on spa usage and bather load, this interval might be shorter or longer. Spas with heavy usage may require a water change every 30-60 days, and spas with minimal usage may require a water change every 90-120 days.

## Clean the cover

May appear every 180 days. This reminder is to remind you to clean your vinyl spa cover, and treat the vinyl cover with a spa UV protectant. This will ensure maximum life of your spa cover.

## Change the UV

May appear on a regular schedule. The UV light may need to be changed, contact your spa dealer for service.

## Change the filter

May appear on a regular schedule every 365 days. Filters when properly maintained should be changed out every 365 days to maintain proper sanitation.

## Check ozone

May appear on a regular schedule. If your spa is equipped with an ozone system, it is recommended to inspect the ozone generator once a year for proper operation.

## Service check - up

May appear on a regular schedule. **This does not indicate that the spa is encountering a problem.** This is just a reminder to inspect the operation of your spa and to contact your spa dealer or the manufacture if anything is not operating as designed.

This Page is Intentionally Blank



## The TP 700 Control System

The TP 700 control panel offered only on spas operating two or more pumps.

Continue to the following pages to learn how to navigate, operate, and program your spas operation. Both control panels use the same software and use the same operation procedures.

### Two Pump Controller







### Three Pump Controller



# MAIN SCREEN ICONS

Important information about the current state of your spa is displayed on the Main screen.

- A - Temperature Range
  - High: **H**
  - Low: **L**
- B - Heat Mode
  - Ready: **R**
  - Rest: **⏸**
  - Ready-in-Rest: **RR**
- C - Ozone Running: **O<sub>3</sub>**
- D - Time-of-Day
- E - Filter Cycles
  - Filter Cycle 1: **F<sub>1</sub>**
  - Filter Cycle 2: **F<sub>2</sub>** (Optional Feature)
  - Filter Cycles 1 & 2: **F+**
- F - Cleanup Cycle (Optional Feature)
- G - Panel Locked and/or Settings Locked
- H - WiFi (Local or Cloud Connection)
- I - Navigation Arrow
- J - Heat Status
- K - Selection Box
- L - Message (May Appear)
  -  Information
  -  Reminder
  -  Error - Normal Error or Warning
  -  Error - Spa will not function until fixed
- M - Water Temperature
  - Fahrenheit temperatures are displayed without decimal points. For example, 100 ° F is displayed as 100.
  - Celsius temperatures are displayed with decimal points. For example, 37.5 ° C is displayed as 37.5.
- N - Water Temperature Bar
- O - Set Temperature Arrow

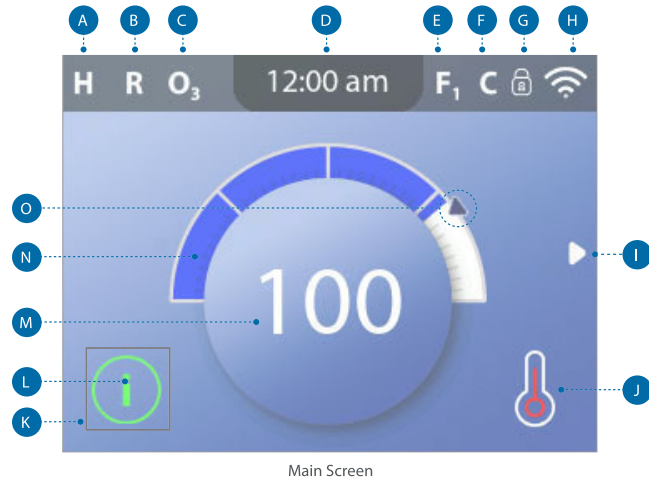

## Spa Device Buttons

These buttons control various spa devices, such as Jets, Lights and/or Blowers.

## Navigation Buttons

Navigate the entire menu structure with the 5 navigation buttons on the control panel.

The names shown to the right refer to the navigation buttons in this user guide. The names will be written in uppercase letters.

Operating or changing a selected item on the panel screen is generally done with the SELECT button (center button).

## Selection Box

The Selection box is a fundamental navigation tool. It indicates a selected item. Move the selection box by pressing the UP, DOWN, LEFT, RIGHT Navigation buttons. When an item is selected, press the SELECT navigation button to act upon the selected item. The next page shows various examples of selected items (C, I, L).

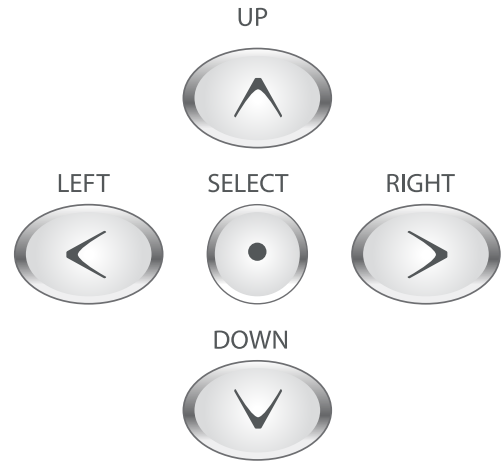



Main Screen

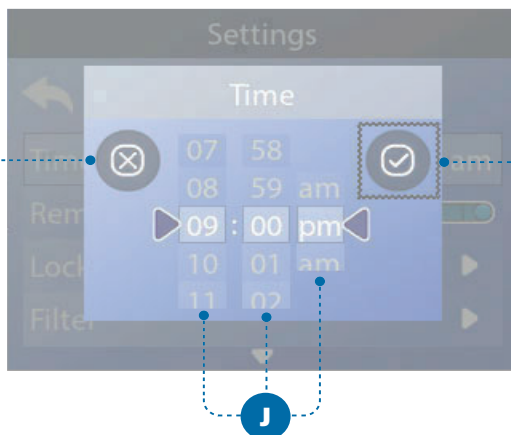
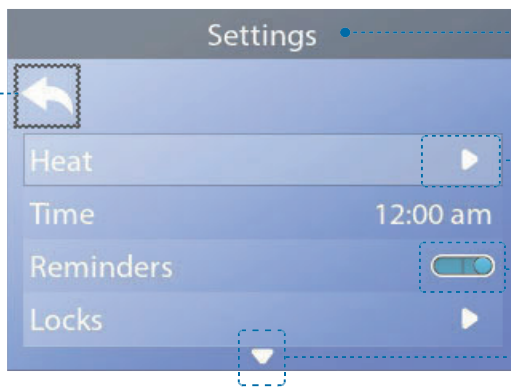
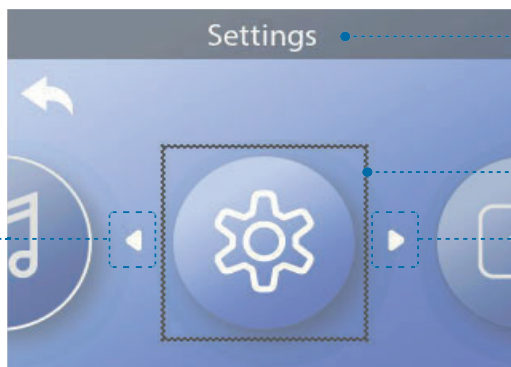
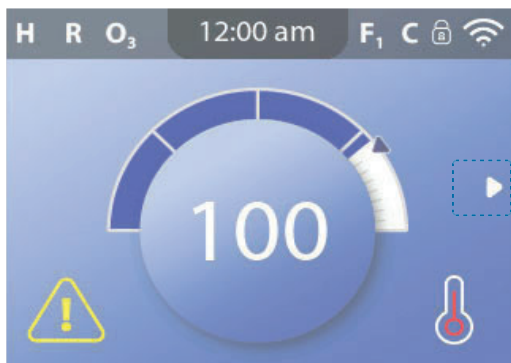

## Menu Navigation

The right Navigation arrow (A) on the Main screen indicates a menu. Press the RIGHT navigation button to enter that menu.

A selection box (C) indicates that a menu item is selected. When a menu item is selected, its name appears at the top of the screen (B). In this example the Settings menu is selected. Press the SELECT navigation button to enter the Settings window (E).

## Navigation Arrows

Navigation arrows (D, F, H, M) indicate more menu items. Each navigation arrow corresponds to a navigation button (view page 8). For example, the right Navigation arrow (D) corresponds to the RIGHT navigation button. The left Navigation arrow (M) corresponds to the LEFT navigation button, etc.

## Back Button

Use the Back button (L) to navigate back in the menus. Use the navigation buttons to select the Back button. The Selection box (L) indicates that the Back button is selected. Press the SELECT navigation button.

## On/Off Switches

In this example the Reminders setting has an On/Off switch (G). When the Reminders setting line is selected, press the SELECT navigation button to turn the switch On/Off. In this example the switch is On (G).

## Select, Save, Cancel

Select one of these columns (J) with the RIGHT and LEFT navigation buttons. Change the selected setting with the UP and DOWN navigation buttons. After you change the settings, choose the Save button (I) and press the SELECT navigation button. After you press SELECT, the change is complete. If you decide to cancel your new settings, select the Cancel button (K) and press the SELECT navigation button.



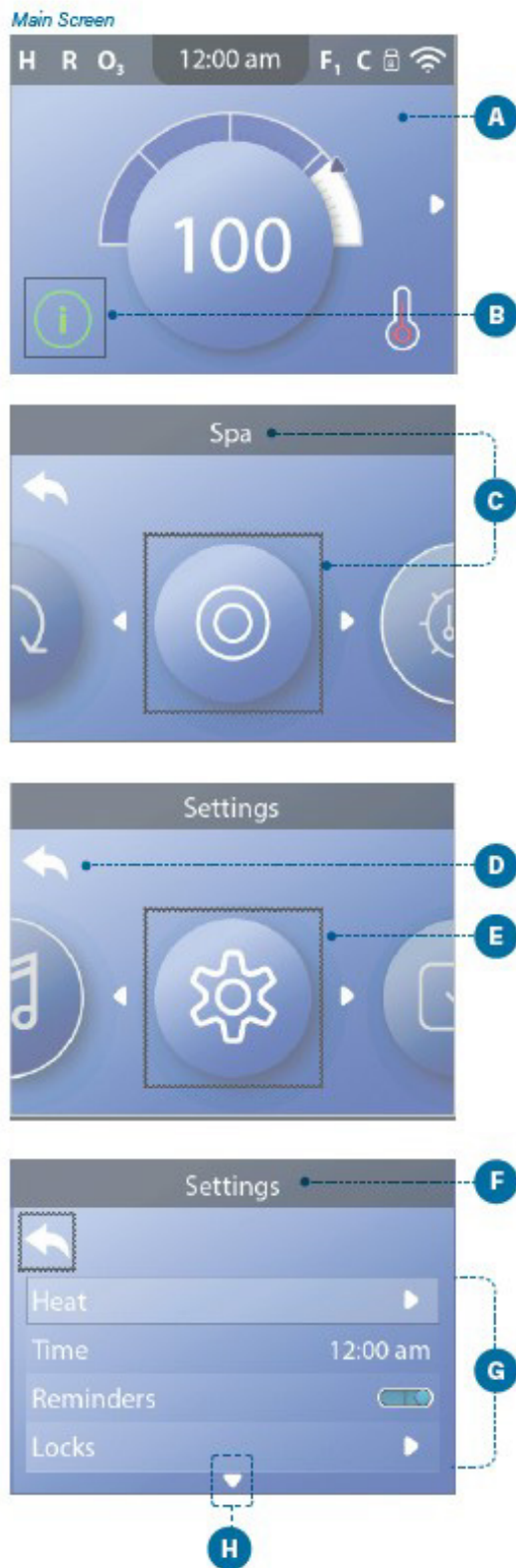

## Navigate the Main menu

1 - Start from the Main screen (A), and press the RIGHT navigation button to enter the Main menu. If the Selection box (B) is on the Message Icon, you need to press the RIGHT navigation button twice to enter the Main menu.

2 - Spa is the first item in the Main menu (C). Continue pressing the RIGHT navigation button to view all items in the Main menu.

3 - If you want to navigate back to the Main screen, press the UP navigation button to select the Back button (D). Once the back button is selected, press the SELECT navigation button and the Main screen (A) will appear.

## Navigate the Settings menu

1 - Start from the Main screen (A), and press the RIGHT navigation button to enter the Main menu.

2 - Spa is the first item in the Main menu (C). Continue pressing the RIGHT navigation button until the Settings menu is selected (E).

3 - Press the SELECT navigation button to enter the Settings menu (F).

4 - The Navigation arrow (H) indicates more settings. Press the DOWN navigation button to scroll down the list.

## Press-and-Hold

If you need to navigate a long list, press-and-hold the navigation button. For example, press-and-hold the DOWN navigation button to scroll down the Settings menu list (G). The Navigation arrow (H) indicates more menu items.

## View Message Screen

1 - Start from the Main screen (A), and press the LEFT navigation button to select the Message Icon (B).

2 - Pressing the SELECT navigation button to view the Message screen.

3 - The Message screen may have an Exit button or a Clear button. Select the button on the screen and press the SELECT navigation button.

# SET TIME-OF-DAY

## Be sure to set the Time-of-Day

Setting the Time-of-Day can be important for determining water filtration times and other background features.

### Follow these steps to set the time-of-day:

- 1 - Navigate to Time (A)\*
- 2 - Press the SELECT navigation button, and the Time screen will appear (B).
- 3 - Use the navigation buttons to adjust your settings (D).
- 4 - Select the Save button (C), and press the SELECT navigation button.

You have set the time-of-day.

If you do not want to save your settings, select the Cancel button (H), and press the SELECT navigation button.

If Time-of-Day has not been set, this Information Icon appears (G). Select the Information Icon and press the SELECT navigation button to view the corresponding message in the Information screen (F). Select the Exit button (E) and press the SELECT navigation button to exit the Information screen.

You can choose a 12-hour or 24-hour time display

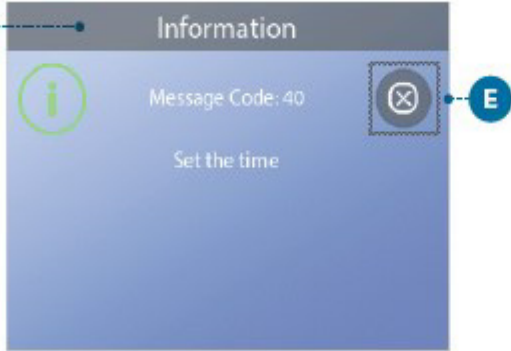
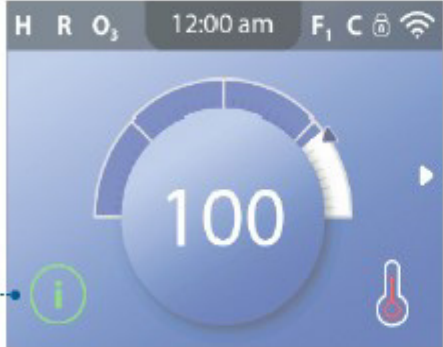
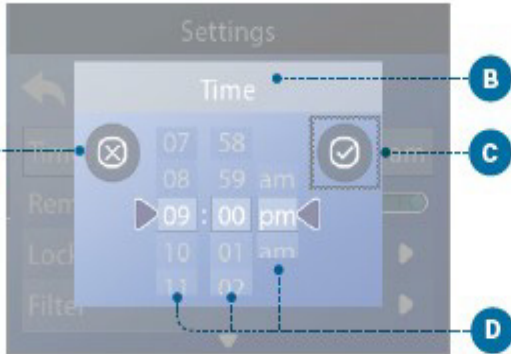
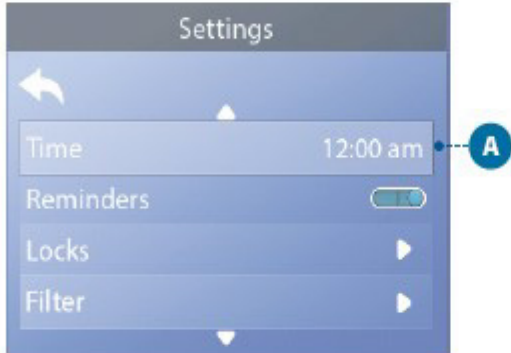

## Main Screen

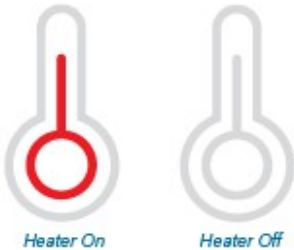
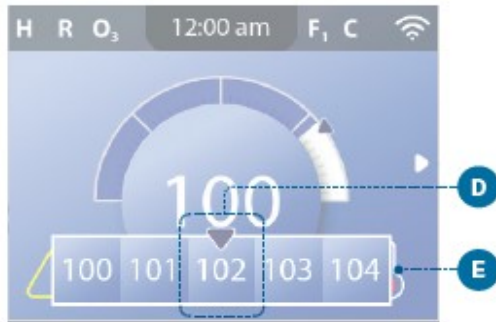

*Note: the Heater Status icon flashes during heater start-up; this is normal.*

# CHANGE THE SET TEMPERATURE

Follow these steps to change the Set Temperature:

1 - Start at the Main screen (A). Press the SELECT navigation button to view the temperature menu (E).

2 - Press the RIGHT and/or LEFT navigation buttons to change the Set Temperature.

The center box (D) indicates the current Set Temperature. In this example the current Set Temperature is 102.

3 - Once your desired Set Temperature is in the center box (D), press the SELECT navigation button, or just wait a few seconds.

The change is complete.

## How do I view the Water Temperature?

The Water Temperature is displayed here (B) on the Main screen.

## How do I view the Set Temperature?

Start at the Main screen (A), and press the SELECT navigation button. The Set Temperature is displayed in the center box of the temperature menu (D).

## How do I know when the water heater is On?

The center of the Heater Status icon turns red (C) when the heater is On, and it turns white when the heater is Off.

## What do the dashes indicate (F)?

When the spa is powered On, four dashes appear (F) in the Water Temperature display for one minute. The dashes indicate that the spa is checking the water temperature. After the pump runs for 1 minute, the dashes disappear and the water temperature is displayed (B). The dashes may reappear after the pump has not run for one hour.

# HEAT MODES

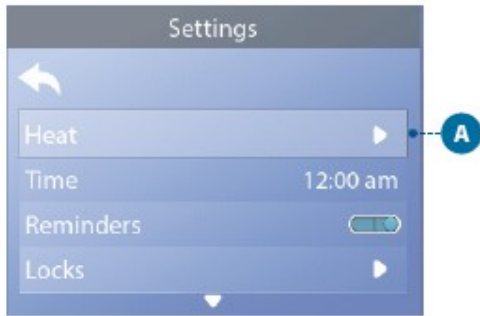

**Follow these steps to view the current Heat Mode and/or change the Heat Mode:**

- 1 - Navigate to Heat (A).\*
- 2 - Press the SELECT navigation button to view the Heat screen (B). The current Heat Mode will appear here (C). In this example the current Heat Mode is Rest. There are two Heat Modes to choose from: Ready, Rest.
- 3 - Press the SELECT navigation button to change the Heat Mode to Ready (D).

You have set the Heat Mode to Ready.

The change takes effect immediately. No need to press a Save button

Ready-In-Rest Mode is a third Heat Mode. But, it is a sub-feature of Rest Mode and is not selectable from the panel menu.

The only place you can see whether you're in Ready-in-Rest Mode is on the Main screen, where it shows all three Heat Modes in icon form.

If you are in Ready-in-Rest Mode, and you want to cancel it (ie, you want to return to Rest Mode), just go view the current Heat Mode (where it will say Rest Mode) and exit. That simple action takes you back to Rest Mode

## Where can I view the current Heat Mode on the Main screen?

The current Heat Mode is displayed here with an icon (E). In this example the current Heat Mode is Ready. The following list shows which icons may appear on the Main screen.

### Heat Mode Icons

Ready: **R**

Rest: **RR**

Ready-in-Rest: **RR**

# TEMPERATURE RANGES

Follow these steps to view the current Temperature Range and/or change the Temperature Range:

1 - Navigate to Heat (A).\*

2 - Press the SELECT navigation button to view the Heat screen (B). The current Temperature Range will appear here (C). In this example the current Temperature Range is Low. There are two Temperature Ranges to choose from: High, Low.

3 - Press the SELECT navigation button to change the Temperature Range from Low to High (D).

You have set the Temperature Range to High.

The change takes effect immediately. No need to press a Save button.

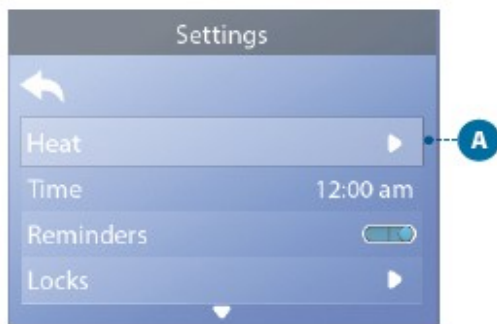

## Can I see the current Temperature Range on the Main screen?

Yes. The current Temperature Range is displayed here with an icon (E). In this example the current Temperature Range is High. The following list shows which icons may appear on the Main screen.

### Temperature Range Icons

High: **H**

Low: **L**

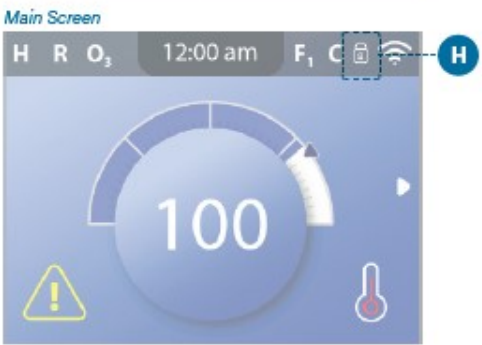
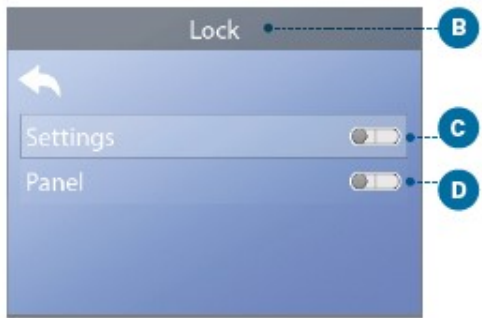

# RESTRICT OPERATIONS

The control can be restricted to prevent unwanted use or temperature adjustments.

Locking the Panel (D) prevents the controller from being used, but all automatic functions are still active.

Locking the Settings (C) allows Jets and other features to be used, but the Set Temperature and other programmed settings cannot be adjusted. Settings Lock allows access to a reduced selection of menu items. These include Filter Cycles, Invert, Information and Fault Log. They can be seen, but not changed or edited.

**Follow these steps to lock the Settings:**

- 1 - Navigate to Locks (A)\*
- 2 - Press the SELECT navigation button to view the Lock screen (B).
- 3 - Navigate to Settings (C). In this example the Settings are unlocked.
- 4 - Press-and-hold the SELECT navigation button for approximately 5 seconds. After 5 seconds, the toggle switch will move to the right and turn blue (G), and a lock icon will appear (E).

You have locked the Settings.

Follow the same steps to lock/unlock the Settings and/or Panel.

- 5 - Navigate back to the Main screen. The lock icon on the Main screen (H) indicates that the Settings are locked.

**Can Settings and Panel be locked simultaneously?**

Yes. The lock icon (H) appears if the Settings or the Panel or both are locked. The current lock states are indicated by the toggle switches in the Lock screen (C, D).

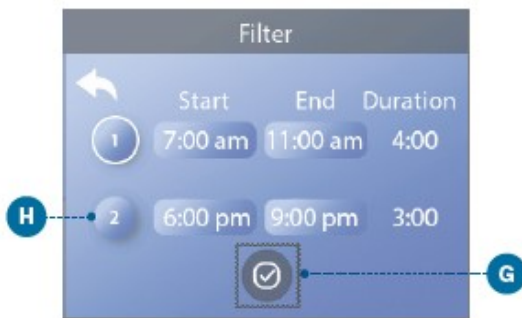
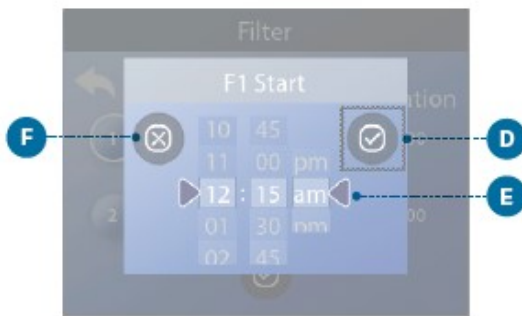
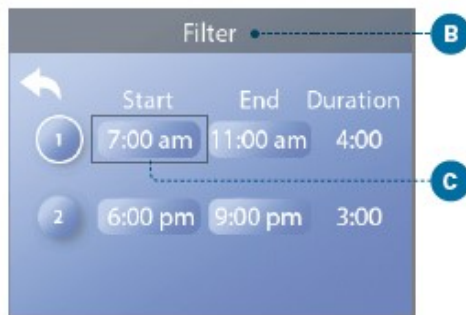
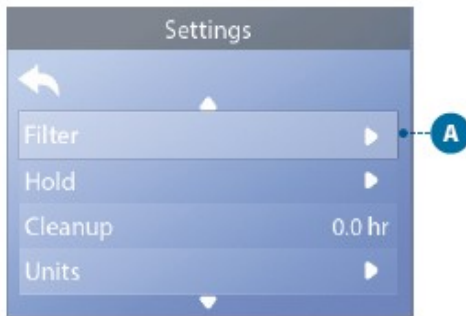
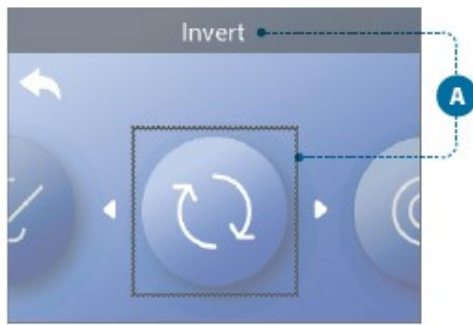

## INVERT DISPLAY

Follow these steps to invert the display:

- 1 - Navigate to Invert (A),\*
- 2 - Press the SELECT navigation button to invert the panel display (B). Every screen will be inverted.

You have inverted the display (B).

Follow the same steps to restore the default display orientation (C).

## SET FILTER CYCLE TIMES

Keep your water clean and ready to enjoy!

Follow these steps to set the Filter Cycles:

- 1 - Navigate to Filter (A),\*
- 2 - Press the SELECT navigation button to view the Filter screen (B).
- 3 - Select the start time for Filter Cycle 1 (C). Press the SELECT navigation button to view the time controls (E).
- 4 - Enter your time settings (E) with the navigation buttons.
- 5 - Select the Save button (D), and press the SELECT navigation button.

You have set the start time for Filter Cycle 1.

If you do not want to save your settings, select the Cancel button (F), and press the SELECT navigation button.

- 6 - Follow the same process to change the other Filter time settings if desired.

- 7 - Once all of the time changes are set, select the Save button (G), and press the SELECT navigation button.

You have set all of the Filter Cycle times.

### How can you tell if Filter Cycle 2 is enabled?

Filter Cycle 2 is enabled when a white ring appears around the 2 (H). In this example there is no white ring, so Filter Cycle 2 is disabled. Filter Cycle 2 is disabled by default on many spas.



This page is Intentionally Blank



## Spa Touch 4+ Control System

### TOUCH TO START

Your Spa Touch 4+ displays by touching anywhere on the screen. Use your fingertip to touch, tap, scroll, slide or swipe to activate the various icons and images on the panel screen.

You will see a "splash" screen, and then a simple at-a-glance temperature and time status.

**NOTE: All features and functions available are shown here. Your system display may vary.**

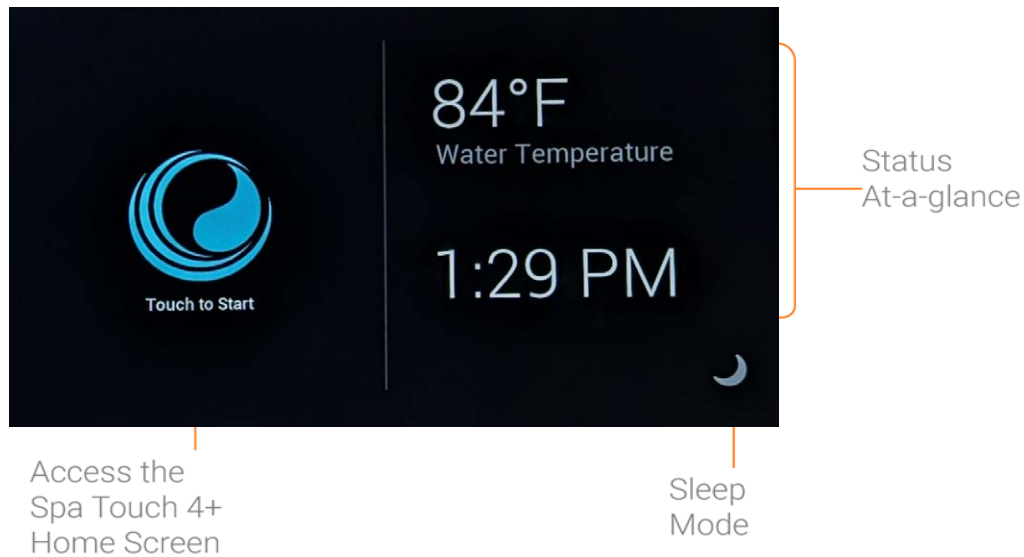

## Navigating Menu Icons

### NAVIGATING HOME

The Spa Touch 4+ Home screen is your central connection to all your panel offers.

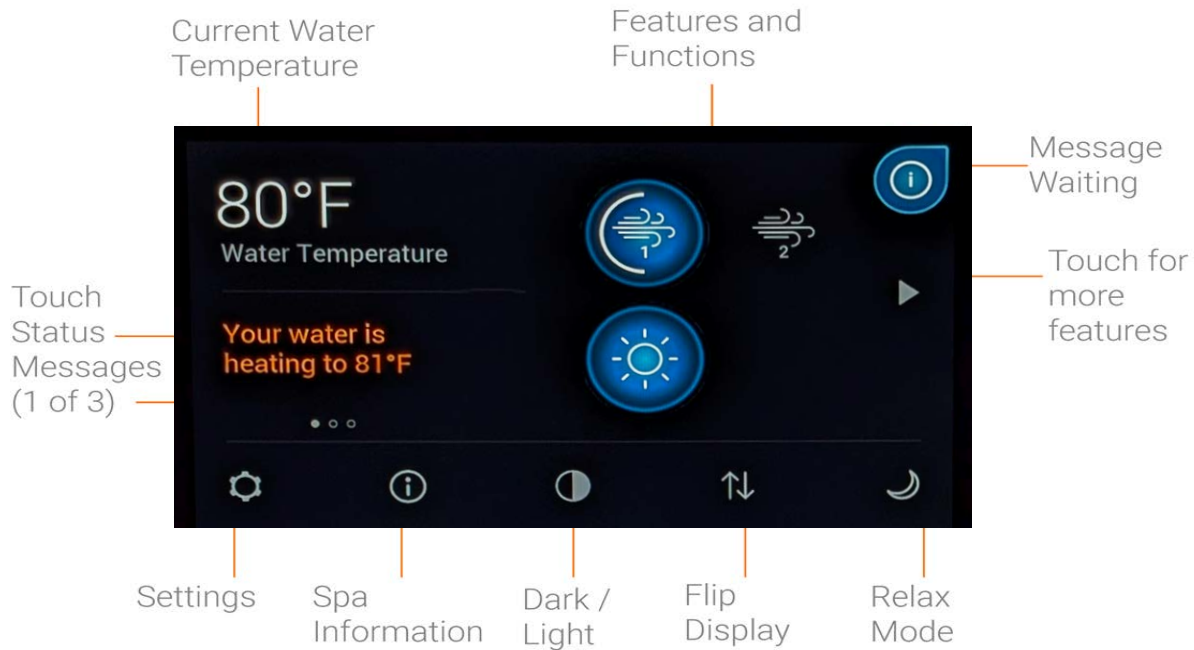

Connected Jets



**\*\*If you spa was equipped with a circulation pump, it will appear on this screen as a pump icon, with arrows surrounding it.**

**You can tap the icon to prime the circulation pump, the pump only activates when heating or during an active filter cycle.**

When the display appears like this, the system is in its "Relax Mode" a minimal screen that is appealing to the eyes.

Pressing the "All Off" icon will turn off all components inside of the spa. The home button will present you to the main screen, where you can access the spas pumps and accessories.



## Priming Your Spa

**Warning:** Prolonged pump operation with an air lock will lead to damage of pumps within your spa. Continued operation would be considered abuse of the spa, voiding the warranty.

To help prevent airlocks from appearing within your spa, fill the spa through the spa filter by inserting inside the filter housing. This allows water to directly go through the primary pump and heater.

Turn each jet on and then off to see that air bubbles are purged. Priming is performed with initial use, and helps to clear waterflow of trapped air or possible stoppage that can strain the system.

### To prime the pump:

- 1 Power up the Spa Touch 4+ during initial use to activate the pump priming mode.  
The message to prime your spa displays.

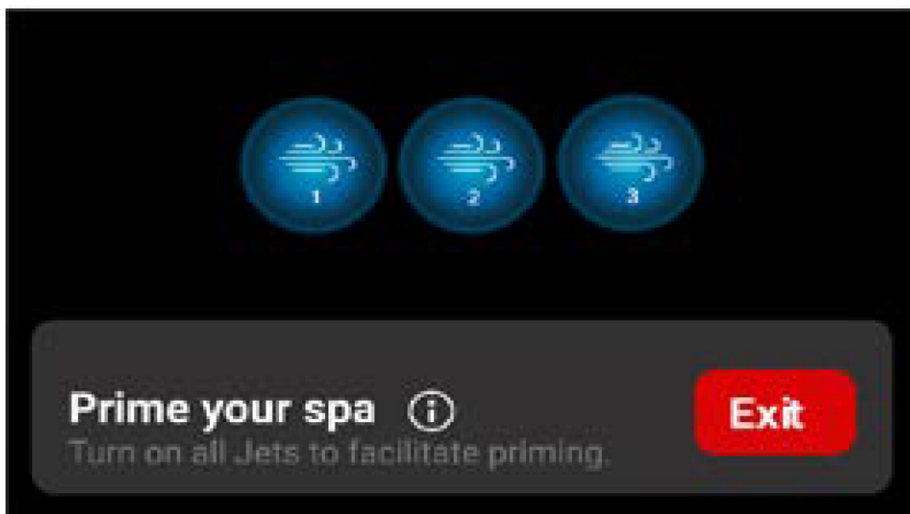

Priming Message

- 2 Touch to turn each jet on and then off to see that air bubbles are purged.  
The jets start up and clear air bubbles from the pipes.

**NOTE:** *During priming, you can manually override, and Touch other features lit on the panel. (lights, misters, blower, etc.). Components and features display dimmed cannot be controlled by your panel.*

After priming, the spa screen lights connected, active features that your panel controls.

**NOTE:** *At minimum, you will always see one pump active for continuous water flow, and filtration through the system.*

# Connecting To Wifi

**IMPORTANT:** Connecting your Spa Touch 4+ to your ControlMySpa account delivers timely updates your system needs for ongoing improvements.

**BEFORE YOU BEGIN:** Have your Wi-Fi network and password available, and also have your CMS Code available, provided by your spa dealer.

## CONNECT WI-FI

To connect to Wi-Fi:

- 1 From Home, touch **Settings**, and then scroll and touch **Wi-Fi**.



Settings Menu

The Wi-Fi Screen displays with available networks.



Wi-Fi Screen

- 2 Touch to connect your spa panel to your Wi-Fi network. A keyboard displays for you to type your network password.



- 3 Enter your network password and touch **Save**.  
"Attempting to connect..." displays, and upon connection, the Wi-Fi screen displays with your newly selected network.
- 4 Touch **Back** < to return to the **Settings Menu**.

## REGISTER YOUR SPA TOUCH 4+

**NOTE:** This step is needed to enable timely updates and use the *ControlMySpa (CMS) App* from anywhere to control your spa and stay current with the panel display improvements.

To register your Spa Touch 4+:

- 5 Touch **ControlMySpa**.

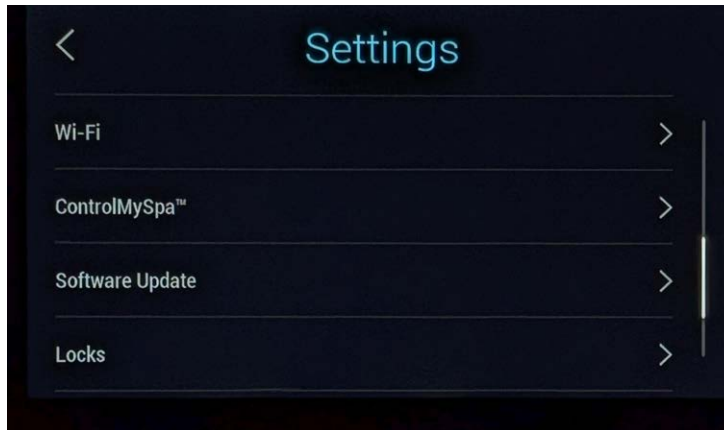

Settings Menu

The ControlMySpa registration screen displays.



ControlMySpa Registration Screen

- 6 Touch the Edit icon , and the keyboard displays.  
Enter the CMS Code supplied by your spa dealer, and then touch **Save**.



**Contact your Spa Dealer or Sales Rep to obtain your unique code.**

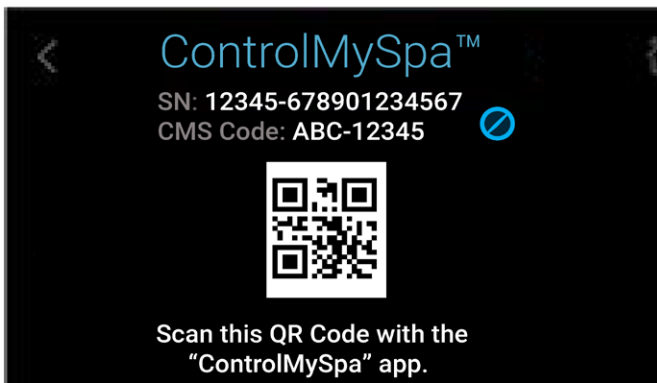

ControlMySpa Screen

- 7 The ControlMySpa screen displays a QR code you will use to pair your spa when you establish your **ControlMySpa** App account. Leave the ControlMySpa screen open on your panel.

### Create a ControlMySpa Account

- 8 Using your mobile phone, go to your App store, and download "**ControlMySpa**."
- 9 Follow the in-app prompts to set up an account, and then **Setup Spa**, and be sure to set up your spa account "by QR code."
- 10 Use your phone's camera to scan the QR code displayed on the Spa Touch 4+ panel, and complete **Spa Account Setup**.

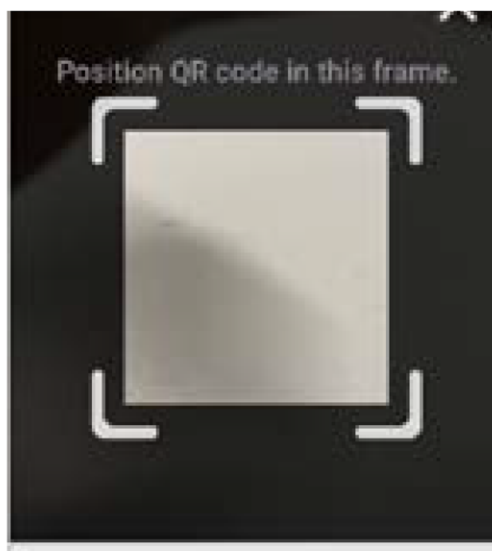

- 11 **IMPORTANT:** When you receive "Account Setup Successful", check your email to authenticate your account.

## Setting Time of Day

The time you set displays on the Home Screen, and becomes your system's time, used to automate the duration of other functions, such as filter cycles, activation and water maintenance for reliable performance.

**IMPORTANT: An iMessage, ⓘ, displays when the time needs to be set, and turns off after you set the time.**

### To set the time:

- 1 From the Home screen, touch **Settings** ⚙️, then **Time**.  
The Time Screen displays.

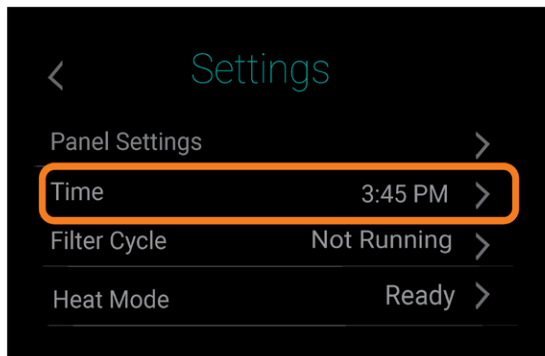

Settings Menu

- 2 Touch and scroll to the current time and **Save**.



Time Screen

The new time is saved, and you can touch **Back** < to set filter cycles next.



# Setting Filter Cycles

Daily filtration assures your spa is operating as designed, and the water is clean and ready to enjoy.

### To set the filter cycle times:

1 From the Home Screen, touch **Settings** and select **Filter Cycles**.



Filter Cycles

The Filter Cycles Screen displays the number of cycles you can schedule.

2 Touch **Filter Cycle 1**.



Filter Cycles

3 Touch **Start** and touch arrows to set the filter cycle starting time. Your desired filter cycle duration adjusts as you make changes.

4 Touch **End** and touch arrows to set the filter cycle ending time. Your desired filter cycle duration adjusts as you change it.

5 Touch **Save**. The Filter Cycles screen displays.

6 Repeat steps 3 through 6 for additional filter cycles, as needed.

7 Touch **Back** to return to the Home Screen.



## Adjust Water Temperatures

Find your current water temperature displayed in large numbers on the Water Temperature reading of the Home screen.

### To set the desired water temperature:

- 1 From the Home Screen, touch the **Water Temperature** area of the screen.

Current Temp &  
Set Point



The Desired Temperature screen displays.

- 2 Touch the **plus +** and **minus -** signs or slide the bar along the bottom of the screen.

**NOTE:** *As the system changes the temperature, the panel reading displays in color.*

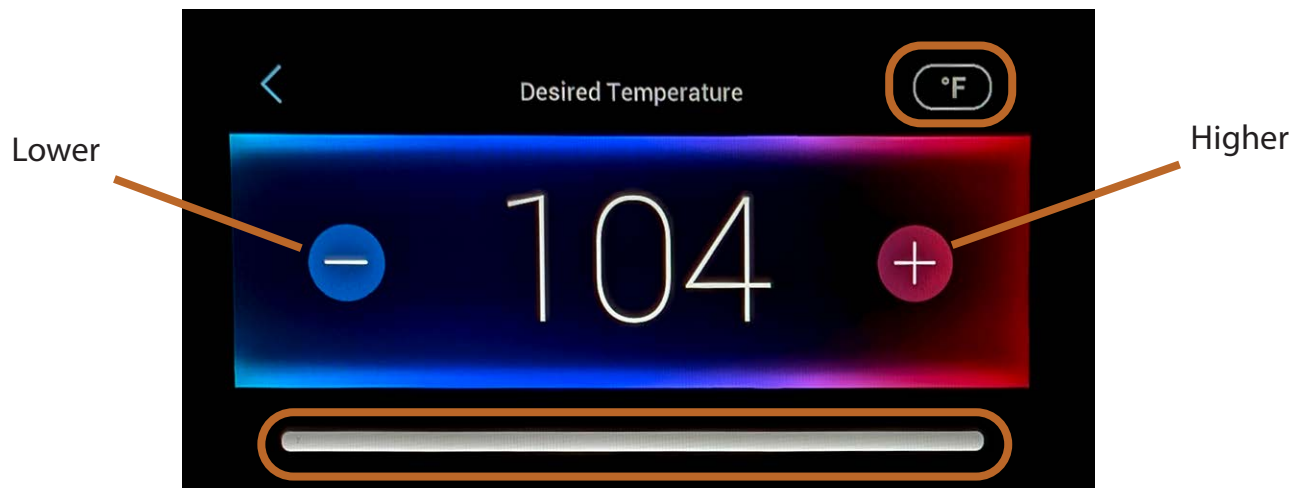

*Desired Temperature Screen*

- 3 Touch the unit of measure, upper right, and touch Fahrenheit (**°F**) or Celsius (**°C**) and change how water temperature unit of measure is displayed.



The system begins to adjust to the newly set temperature.

- 4 Touch **Back** < to return to the Home Screen.

# Activating Jets/Pumps

Turning on the jets provide the water pressure and motion for an enhanced, therapeutic soak.

## To turn on the jet:

- 1 From the Home Screen, touch the available **Jet**  to activate, and touch the arrow  to see more features.



The Spa Features display with additional components connected to your system.

- 2 Touch on each lit jet.

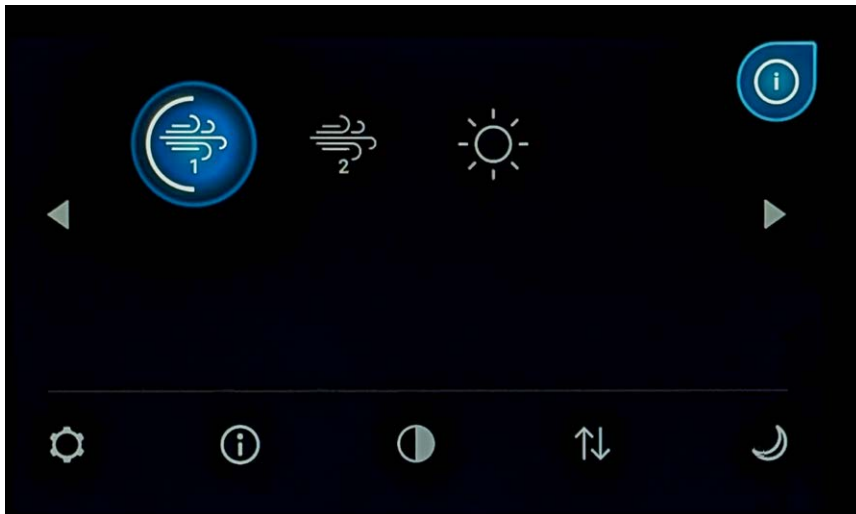

**\*\*Some spas are equipped with more than two pumps will show multiple pump icons on the screen, one for each pump**

Spa Features

- 3 Touch the arrow  to display the Home Screen.



## Adjust Screen Brightness

Adjust your panel display brightness.

**To change the display brightness:**

- 1 From the Home Screen, **Settings** ⚙️, touch Panel Settings

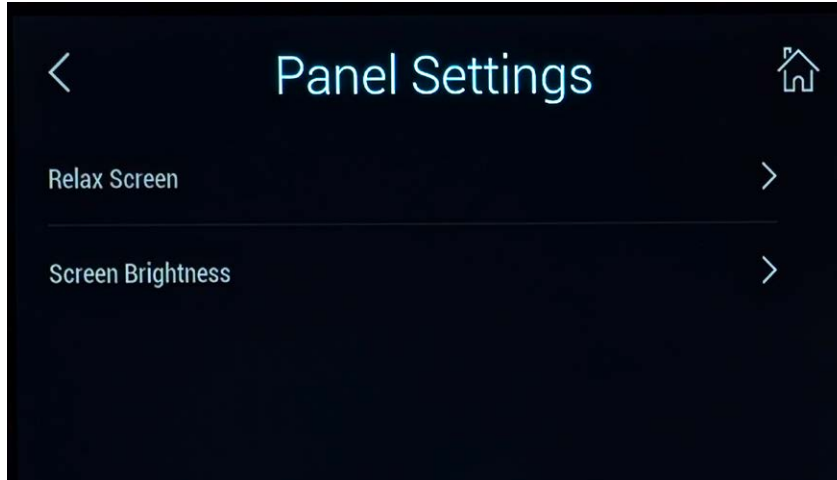

The Screen Brightness slider displays with the Brightness Slider along the screen bottom.

- 2 Touch the **plus +** and **minus -** signs or slide the bar on the screen to adjust your desired level of brightness.

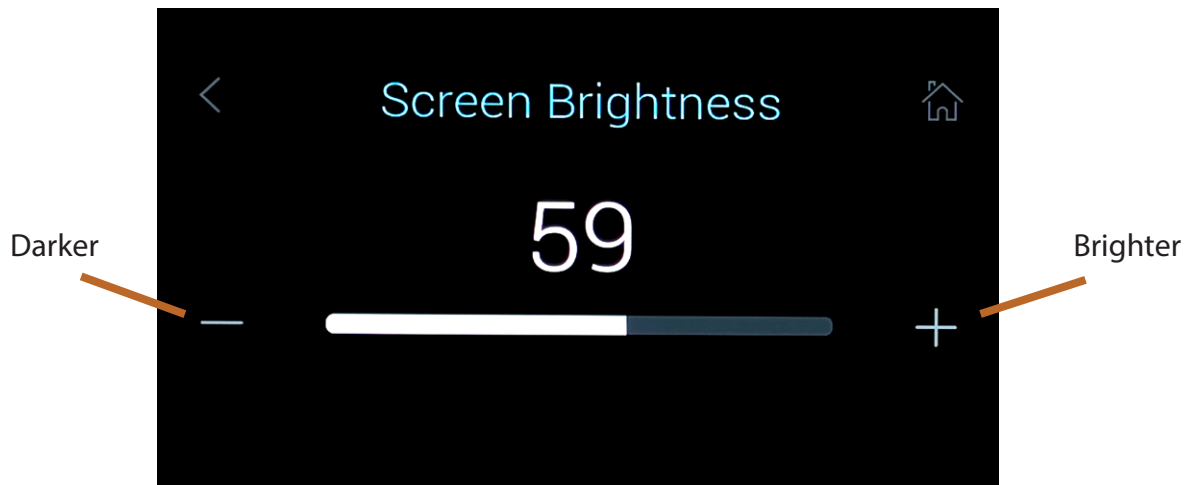

- 3 Touch **Home** 🏠 to return to the Home Screen.



**NOTE:** All features and functions available are shown here. Your system display may vary.

Keep your spa heated with these options: Run the spa continuously, as Ready (R) state or Rest state (IR) for energy efficiency.

## To change the heat mode:

- 1 From the Home Screen, touch **Settings** ⚙️.



Touch "Heat Mode"

The Settings Menu displays.

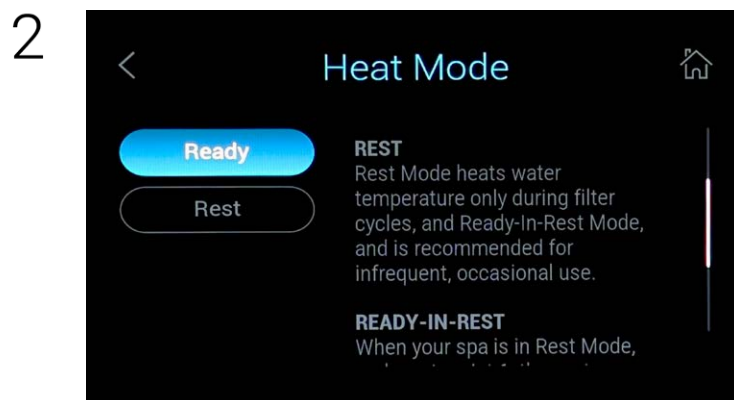

The Heat Mode Screen displays.

- 3 Touch to change the Heat Mode. Options are:  
**Ready** - regulates temperature continuously, and best for frequent, scheduled use.

**Rest** - regulates temperature only during filter cycles.

**Ready-In-Rest** - When your spa is in Rest Mode, and you touch **Jet 1** 🌊, the system switches to Ready-In-Rest Mode and heats the water to the desired temperature for one hour. Then, the spa returns to Rest Mode.

**NOTE:** To cancel Ready-In-Rest and return back to Rest Mode within the hour, perform step 3 and select Ready setting.

- 4 Touch **Home** 🏠 to return to the Home Screen.

## TEMPERATURE RANGE

Set within two separate temperature ranges, L (Low) and H (High). **High** allows you to set your temperature between two limits in a high range. **Low** allows you to set your temperature between two limits in a low range. The range displays as you set the desired water temperature.

### To change the range between High and Low:

- 1 From the Home Screen > **Settings** ⚙️, touch **Temperature Range**.



*Settings Menu*

The Temperature Range Screen displays.

- 2 Touch either **High** or **Low** to select the range in which the water temperature heats or cools within the range.

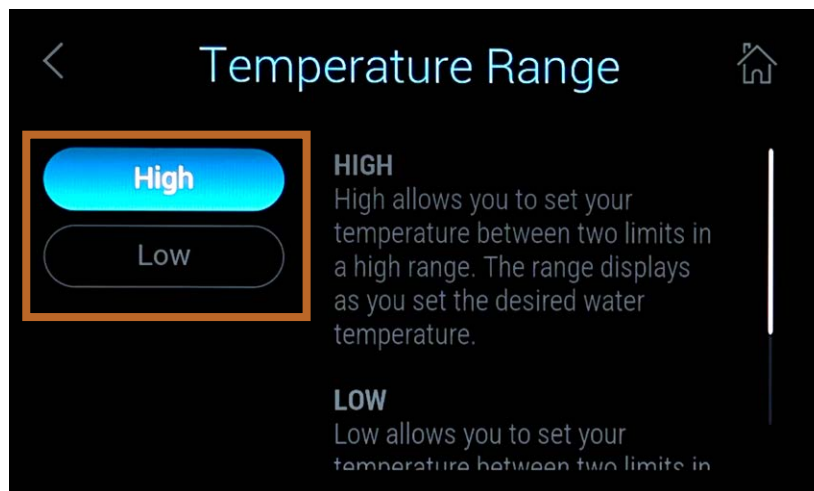

*Temperature Range*

- 3 Touch **Home** 🏠 to return to the Home Screen.

# Diagnostics

Find your system settings and fault log record here, including System Information and Fault Log.

## SYSTEM INFORMATION

### To find your system Information:

- 1 From the Home Screen, touch **Settings** ⚙️, and scroll to touch **Diagnostics**.

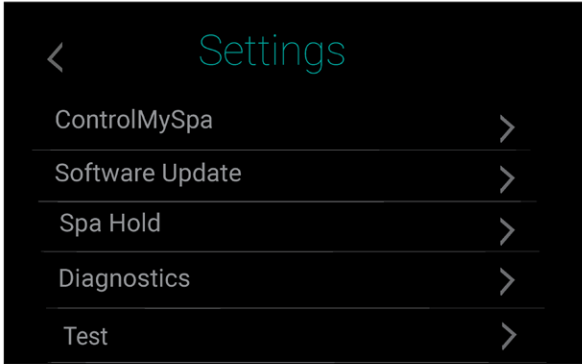

Settings Menu

The Diagnostics Menu displays access to two status pages:

- 2 Touch System Information or Fault Log to see corresponding displays.

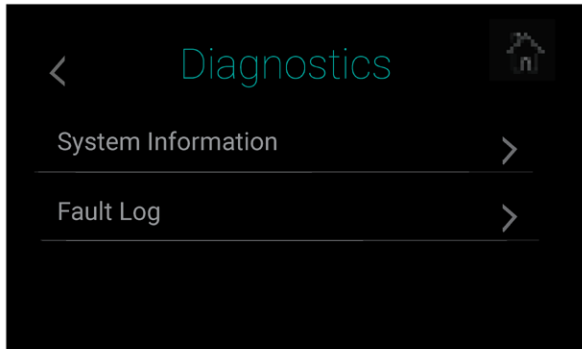

Diagnostics Menu

- 3 Touch System Information or Fault Log to see corresponding displays. Your selected information displays.



# General Messages & Heater-Related Messages

## Water is too hot - M029

The system has detected water temp of 110°F (43.3°C) or more, spa functions are disabled. The system will auto reset when the spa water temp is below 108°F (42.2°C). Check for extended pump operation or high ambient temp.

## Water flow is low - M016

There may not be enough water flow through the heater to carry the heat away from the heating element. Heater will attempt to start up again after 1 minute. Correct any water flow restrictions.

## Water flow has failed - M017

There is not enough water flow through the heater to carry the heat away from the heating element and the heater has been disabled. After the problem has been resolved, reset the message.

## The heater may be dry - M028

Possible dry heater, or not enough water in the heater to start it. Shut down the spa for 15 min to reset this message. Call for service if this message does not clear, as there could be an issue with your sensors or your spa pumps.

## The heater is dry - M027

There is not enough water in the heater to start it. The spa is shut down. After the problem has been resolved, you must reset the message\* to restart heater start up.

## The heater is too hot - M030

This code occurs when, one of the water temp sensors has detected 118°F (47.8°C) in the heater. When this happens the spas current operations will shut down. You must reset the message, and this message will not reappear, when the water in the heater is below 108°F (42.2°C).



# Sensor-Related Messages

## Sensors are out of sync - M015

When this error code appears, the temperature sensors may be out of sync by 3°F. Call your dealer for service, if this message does not disappear within a few minutes.

## Sensors are out of sync - M026

This code is specific to when the system has detected a consistent temperature difference between the sensors of 3°F or more. Contact your spa dealer for service.

## Sensor A/B Fault - M031/M032

Either temperature sensor A, B, or both have failed due to a circuit failure. Call your spa dealer for service.

## Communications Error

The control panel is not receiving communications from the control system, call your spa dealer for service.

# System-Related Messages

## Settings have been reset - M021

Contact of spa dealer if this message appears on more than one power up. This could be an internal memory issue.

## The clock has failed - M020

The internal clock in your control system has failed. Contact your spa dealer for service.

## GFCI Test has failed - M036

Indicates the failure of an automated GFCI self test. This highlights a possible issue with your spas GFCI electrical circuit.

## A pump may be stuck on M034

Indicates the failure of an automated GFCI self test. This highlights a possible issue with your spas GFCI electrical circuit.

## Hot fault - M035

A pump is possibly in a stuck on position when the spa was last powered on. Meaning the electrical switch controlling the pump is stuck in the on position, ignoring the switch off command. DO NOT ENTER THE SPA, DO NOT ENTER THE WATER. Contact your spa dealer for service.

# Reminder Messages

## Check the PH

May appear on a regular schedule, i.e. every 7 days. Check pH with a test kit and adjust pH with the appropriate chemicals.

## Check the Sanitizer

May appear on a regular schedule, i.e. every 7 days. Check sanitizer level and other water chemistry with a test kit and adjust with the appropriate chemicals.

## Clean the Filter

May appear on a regular schedule every 30 days. Rinse the filter cartridge out and gently reinstall.

## Test the GFCI

May appear every 30 days. The GFCI is an important safety device that should be tested to verify its reliability.

## Change the Water

May appear every 90 days. A general recommendation of draining the spa and using new water to ensure water clarity and proper sanitation. This interval is dependent on spa usage and bather load, this interval might be shorter or longer. Spas with heavy usage may require a water change every 30-60 days, and spas with minimal usage may require a water change every 90-120 days.

## Clean the Cover

May appear every 180 days. This reminder is to remind you to clean your vinyl spa cover, and treat the vinyl cover with a spa UV protectant. This will ensure maximum life of your spa cover.

## Change the UV

May appear on a regular schedule. The UV light may need to be changed, contact your spa dealer for service.

## Change the Filter

May appear on a regular schedule every 365 days. Filters when properly maintained should be changed out every 365 days to maintain proper sanitation.

## Check Ozone

May appear on a regular schedule. If your spa is equipped with an ozone system, it is recommended to inspect the ozone generator once a year for proper operation.

## Service Check - Up

May appear on a regular schedule. **This does not indicate that the spa is encountering a problem.** This is just a reminder to inspect the operation of your spa and to contact your spa dealer or the manufacture if anything is not operating as designed.

This Page is Intentionally Blank



## Cal Connect RF Set Up Guide

**Congratulations!** Welcome to Cal Connect Control My Spa, the smart control system for spa monitoring on the go. With Cal Connect you will be able to control/monitor water temperature, control pump operation, adjust filtration, and monitor/control any activity occurring within your spa.

This Quick Start guide will help you with initial set up of your RF module.

**NOTE: The Cal Connect Module works on 2.4 Ghz networks only. Inspect your router to confirm 2.4 Ghz support.**

The Cal Connect uses two modules, one that connects to the home router and one that connects to the spas control box, both modules must have matching serial numbers located on the back of each of the modules. Connect your home module first before proceeding.



For Spas With TP-700 or Touch 2 Displays Only

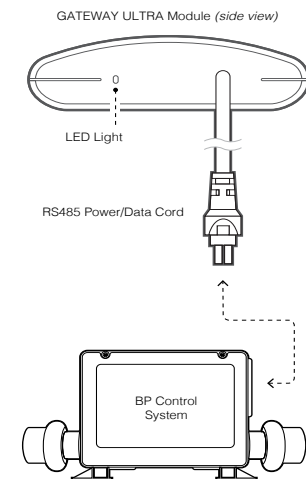
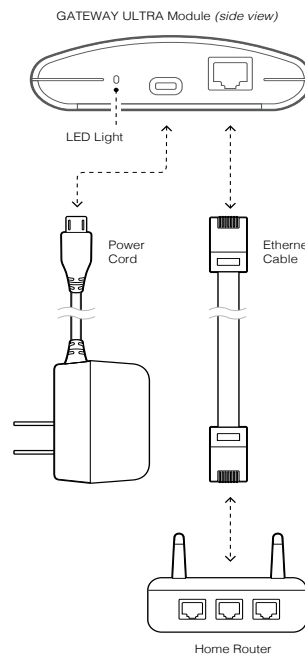
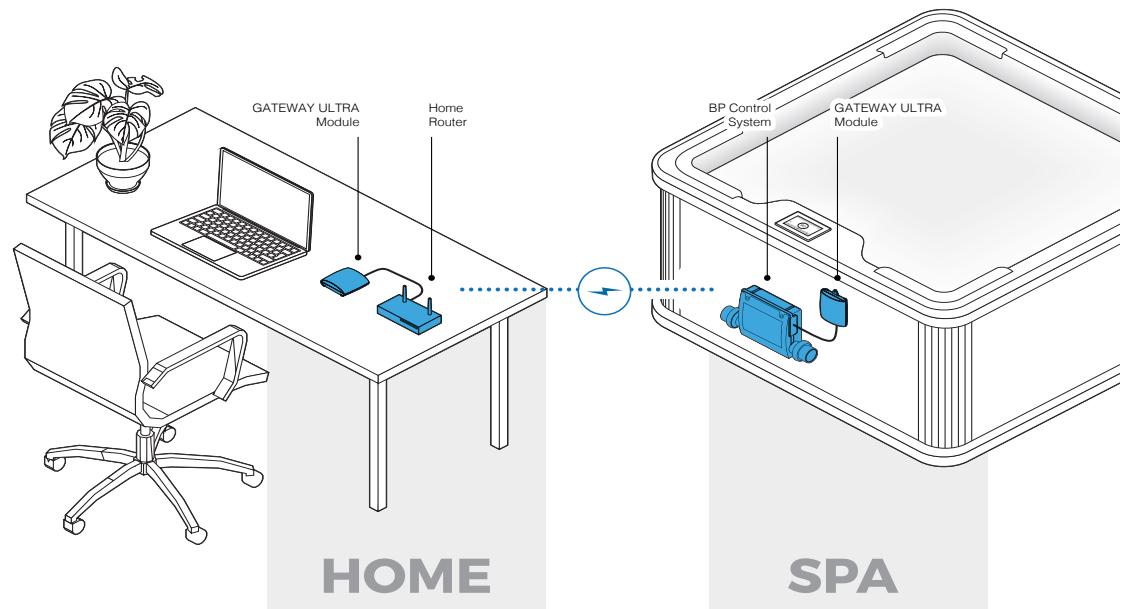



## Download the Control My Spa App

To Begin the initial set up of the Cal Connect system, download the "Control My Spa" app by Balboa Water Group from the App Store or Google Play Store.

Before starting the app, have your CMS code in hand. This is a unique code provided to you by your dealer.

**If you do not have a CMS Code, Please Contact your dealer.**

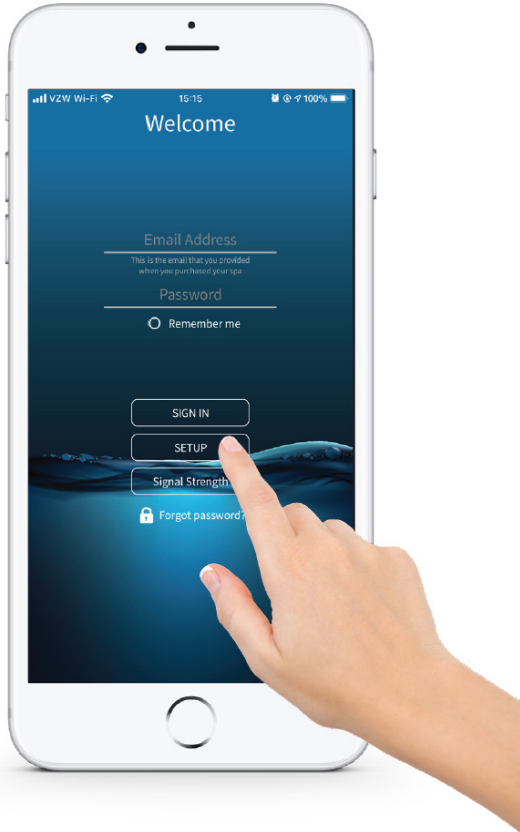
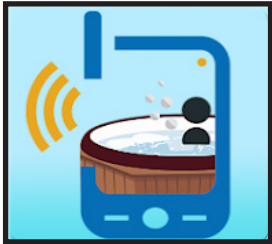

**1-** In your phone setting ensure that your bluetooth setting is toggled on, during initial set up the module uses bluetooth to communicate.

**2-** To set your module into discovery mode, flip your spa GFCI breaker off and back on again.

**3-** Next, open the Control My Spa app and and select "SETUP" to begin the process of registering your modules.

**4-** Stand next to the spa, perferably near the control panel of your spa. your mobile device will begin searching for the spa module.

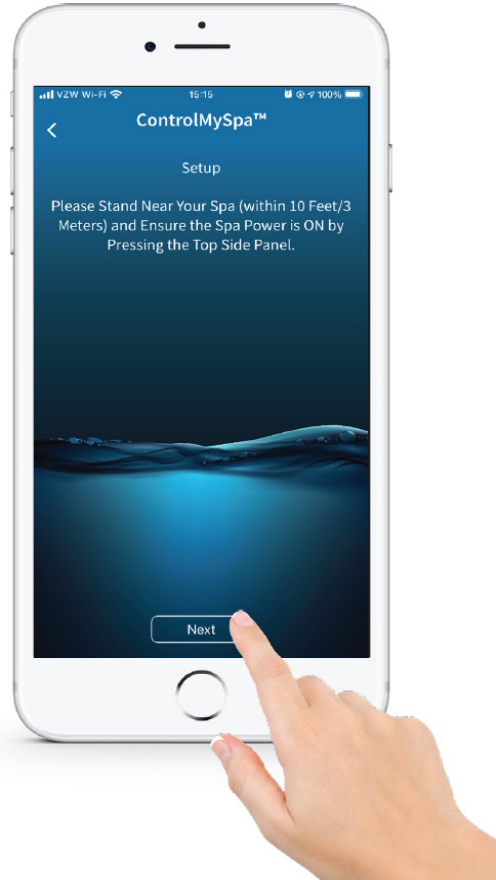

## Control My Spa Set-Up



**5-** The App will begin scanning for the spas wifi module. within a few seconds the module serial number should appear.

**6-** Select the "Yes" option once the serial number appears on screen and proceed with the following steps.

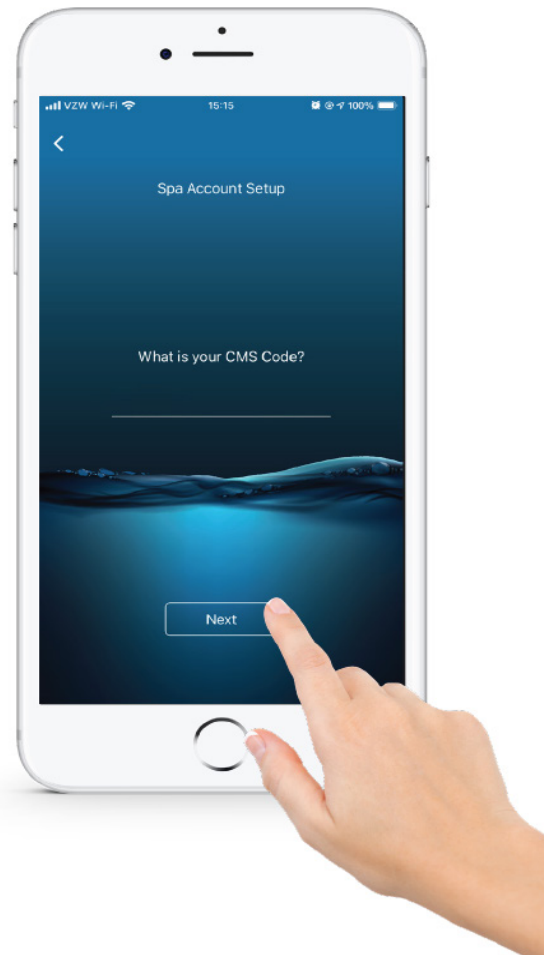

**7-** The app will request your CMS Code to proceed with creating an account to control your spa.

**If a CMS Code was not given to you, please contact your dealer.**

**8-** Proceed with account creation, once completed with all steps log into your newly created account on the main page of the app. once you are logged in you should have control of your spa system within 5-10 minutes.

For more details on installation and basic troubleshooting you can download the complete installation/owners manual on <https://www.balboawatergroup.com/getdoc.cfm?id=2392> To download the full manual.

## Energy Consumption Tips

Your new spa comes equipped with an electric heater. Following the directions listed below will ensure the most efficient operation:

**NOTE: This method is only for spa usage under two hours a week.**

- Keep the spa’s operating temperature 5°F below the desired usage temperature when not in use. One or two hours before use, set the temperature to the desired temperature.
- If the spa usage exceeds two hours a week, the set temperature should remain at the desired usage temperature.
- The air venturis should be used sparingly when open, water temperature drops quite rapidly and can also dissipate chemicals

Allowing the water temperature to lower more than 10°F below the desired usage temperature and reheating it prior to usage will cause the heater to operate longer than it normally would maintaining the desired temperature. Doing this will increase your operating cost and make your heater work more than necessary.

## Spa Jets

Almost all of the jets in your spa are adjustable. Rotating the face of an adjustable jet to the left (counter-clockwise) will decrease the amount of water flow through the jet. Rotating the face of an adjustable jet to the right (clockwise) will increase the amount of water flow through the jet. (See example shown to the right.)

Neck jets adjust in the opposite directions (counter-clockwise to increase, clockwise to decrease).



## LED Lighting

Press the LIGHT button on the topside control panel to turn the spa light on. If your spa has perimeter LED lights, they will also light on. If your spa has perimeter LED lights, they will also light up at the same time as the spa light.

The LEDs operate in three modes:

**1. Cycle:** When you continually press the LIGHT button, the LEDs will cycle through the three main LED colors (Red, Green, and Blue) or combinations of the three that produce the following colors: light green, purple, light blue, yellow, etc.

Each time you press the button, you immediately advance to the next color in sequence or eventually a different light pattern.

**2. Flashing:** Once you have cycled through all of the colors, another press of the LIGHT button will produce a flashing pattern.

**3. Fading cycle:** The next phase of operation when you push the LIGHT button is a slow and/or fast fade random transition from one color to the next.

- If a spa is equipped with more than 100 points of light the slow fading cycle will flicker during a color change.
- Every air valve is equipped with 2 LED points.
- Perimeter LEDs take 9 points of light.
- The waterfall takes 4 points of light.

Spas with exterior corner LED lighting generally work in the same mode as described above. The variations in color and patterns provide you with multiple options to suit almost any lighting preference.

## Diverter Knobs

Diverter knobs are 1" and 2" knobs located around the top of your spa. They allow you to divert water through jets from one side of the spa to the other, or in most cases from floor jets to all jets. This is accomplished by rotating the diverter knob to the left (counter-clockwise), decreasing the amount of water flow through a section of jets. To increase the amount of water flow through the other section of jets, rotate the handle to the right (clockwise)



## Air Venturis

Air venturis are the 1" knobs located around the top of your spa. Each one will let you add a mixture of air with the jet pressure. This is accomplished by rotating the air venturi knob to the left (counter clockwise) to increase the amount of air flow. To decrease the amount of airflow through the jets, rotate the handle to the right (clockwise)



## Hydro Streamers

Your spa may include two to eight streamer waterfalls. When the booster pump is on, turn the 1" diverter knob to adjust the rate of flow to the waterfall jets.

The waterfall jet faces are not adjustable. Do not turn the jet faces because you may accidentally remove them. Always shut off water to the hydro streamer jets before you place the cover on the spa. Water from the hydro streamer jets sprays in an arc that is higher than the top surface of the spa. When water from the hydro streamer sprays the bottom of the cover, it will collect and run to the edge of the spa and drip over the top.





## Water Clarity

This section is intended for new spa owners who are not familiar with adjusting spa water chemistry. Everyone’s knowledge with maintaining water quality is different, but there are some general concepts you need to know.

Water maintenance is not difficult, however it is something that requires regular attention. The most important thing to understand about taking care of your spa water, is that preventative action is easier than corrective action when balancing chemistry and maintaining water clarity

Before beginning, we recommend you become familiar with some water quality terms and their definitions within this following section.

### 1. Chemical Balancing

#### Learning how to properly balance your water.

You will need to test and adjust the chemical balance of your spa water, this is not a difficult task but it must be done regularly. Important areas to focus on with water chemistry is the calcium hardness, total alkalinity, and the pH range.

Spa owners with salt generators will need to perform a total dissolved solids and phosphate test.

### 3. Filtration

#### Learn how to properly clean your filter

Cleaning your filter cartridge is the easiest and most effective thing you can do to keep your spa water clear.

A clogged dirty filter will cause the heater and pump to work harder than they need to, possibly causing them to fail.

The spa’s heating system will only function with the proper amount of water flow through the system.

### 2. Sanitation and Shock

#### Learning how to properly sanitize and shock your spa.

Sanitizers kill bacteria and viruses and keeps your water clean. A low sanitizer level will allow microbes to grow quickly in the spa water . We recommend using either granulated chlorine or bromine as your sanitizer.

You also need to add shock to the water to stimulate the chemical sanitizer. How much you use and how often you use sanitizers, depends on how frequently the spa is used.

### 4. Consistency

#### Make checking your spa part of your daily routine.

Clear water requires regular maintenance. Establish a routine based on a regular schedule, testing your water on a daily basis.

Maintaining your water quality helps the enjoyment of your spa and extends the lifetime of spa components by preventing damage from neglect and chemical abuse.

## Water Quality Terms and Definitions

The following chemical terms are used in this section. Understanding their meaning will help you to better understand clear water maintenance. Words in bold type are defined in this table.

<b>Bromine / Bromamines</b>	<p><u>Bromine</u> is an efficient sanitizer chemical for spas. When used as a <b>sanitizer</b>, bromine forms compounds called bromamines. Bromine can be added to the spa or automatically generated.</p> <p><u>Bromamines</u> are compounds formed when bromine combines with nitrogen from body oils, perspiration, etc. Unlike chloramines, bromamines have no pungent odor and are effective sanitizers.</p>
<b>Chlorine / Chloramines</b>	<p><u>Chlorine</u> is an efficient sanitizing chemical for spas. We recommend using sodium dichlor-type granulated chlorine because it is totally soluble and nearly <b>pH</b> neutral. When used as a <b>sanitizer</b>, chlorine forms compounds called chloramines.</p> <p><u>Chloramines</u> are compounds formed when chlorine combines with nitrogen from body oils, perspiration, etc. Chloramines can cause eye irritation as well as having a strong odor. Unlike <b>bromamines</b>, chloramines are weaker, slower <b>sanitizers</b>. To remove chloramines, see the description of <b>shock</b> below.</p>
<b>Calcium Hardness</b>	Abbreviated as CH. Calcium hardness is a measure of the total amount of dissolved calcium in the water. Calcium helps control the <b>corrosive</b> nature of the spa's water and is why soft water is not recommended. The low CH level can cause <b>corrosion</b> to the equipment and can cause staining of the spa shell.
<b>Corrosion</b>	The gradual wearing away of metal spa parts, usually caused by chemical action. Generally, corrosion is caused by low <b>pH</b> or by water with levels of <b>TA</b> , <b>CH</b> , <b>pH</b> or sanitizer which are outside the recommended ranges.
<b>Dichlor</b>	Also called sodium dichlor. It is a type of chlorine and is frequently used when <b>shocking the water</b> . An effective <b>chlorine</b> -based powdered <b>oxidizer</b> and <b>sanitizer</b> . Dichlor works by oxidizing waste product in the water such as <b>bromamines</b> and <b>chloramines</b> and causing them to burn off.
<b>Monopersulphate or MPS</b>	Frequently used when <b>shocking the water</b> . An effective non-chlorine-based powdered <b>oxidizer</b> that works well with both <b>chlorine</b> and <b>bromine</b> . It works by oxidizing waste product in the water such as <b>bromamines</b> and <b>chloramines</b> and causing them to burn off.
<b>Oxidizer</b>	<b>Shocking the water</b> with an oxidizing chemical prevents the buildup of contaminants, maximizes <b>sanitizer</b> efficiency, minimizes combined <b>chlorine</b> and improves water clarity.
<b>Ozone</b>	Ozone is a powerful oxidizing agent which is produced in nature and artificially. Ozone forms no by-products of <b>chloramines</b> (ozone actually oxidizes chloramines) and will not alter the water's <b>pH</b> .
<b>pH</b>	The pH level is the measure of the balance between acidity and alkalinity. Low pH causes the water to be too acid, which will cause <b>corrosion</b> , whereas high pH causes the water to be too alkaline, which will cause <b>scaling</b> . See page for testing for and balancing pH.
<b>ppm</b>	The abbreviation of "parts per million", the standard measurement of chemical concentration in water. Identical to mg/l (milligrams per liter).
<b>Sanitizer</b>	Sanitizer is a chemical added to the water to kill bacteria and viruses and keep the water clean. The two sanitizers we recommend are <b>chlorine</b> and <b>bromine</b>

**Scale** Rough calcium-bearing deposits that can coat spa surfaces, heaters, plumbing lines and clog filters. Generally, scaling is caused by mineral content combined with high pH. Additionally, scale forms more readily at higher water temperatures.

**Shock** Also called shocking the water, shock treatment, or superchlorination. Shocking the water is adding significant doses of **dichlor** or **MPS** to **oxidize** non-filterable organic waste and to remove **chloramines** and **bromamines**. Shock treatment breaks down organic waste contaminants which cause odor and cloudy water.

**Total Alkalinity** Abbreviated as TA. Total alkalinity is the measure of the total levels of carbonates, bicarbonates, hydroxides, and other alkaline substances in the water. TA is important for pH control. If the TA is too low, the pH will fluctuate out of control, and if it is too high, the pH becomes difficult to stabilize.

**Trichlor** Used as a pool sanitizer. NEVER use trichlor in a spa. Trichlor is extremely acidic and will lower the pH, causing corrosion to equipment. Using trichlor will void your warranty.

### Water Testing Methods

There are two testing methods to choose from:

Test strips are a convenient testing method commonly used by spa owners.



The reagent test kit is a method which provides a high level of accuracy but is more expensive and more difficult to use if not experienced with this testing method.



### Adding Chemicals to the Spa

**IMPORTANT:** All spa water chemicals, including MPS (Shock), chlorine, granulated pH increaser or decreaser, granulated total alkalinity increaser, calcium hardness increaser, liquid stain and scale inhibitor, and liquid de-foamer must always be added into or in front of the filter compartment while the primary jet is running for a minimum of 10 minutes.

1. - Fold back the cover.
2. - Press the Jets button or Jet 1 button (Touch devices, activate pump 1)
3. - Carefully measure the recommended amount of chemical and slowly pour it into the filter area. Use care not to splash chemicals on your hands, clothes, eyes, or spa surface/siding
4. - Close the spa cover

**Warning:** High sanitizer levels can cause discomfort to the user's eyes, lungs, and skin. Always allow the sanitizer level to fall into the recommended range before using the spa.

**IMPORTANT NOTE REGARDING SHOCK TREATMENT:** After administering shock to your spa, leave the cover open for a minimum of 20 minutes to allow the oxidizer gas to vent into the atmosphere. A high concentration of trapped oxidizer gas which may exist as a result of the shock treatment (not daily sanitation) may eventually cause discoloration or vinyl degradation to the bottom of the cover. This type of damage is considered chemical abuse and is not covered under the terms of the limited warranty.

## Balancing Water Chemistry Levels

Maintaining spa water chemistry can be tricky, especially since there are many methods of keeping your water clear and clean. Note: We do not recommend a specific brand of chemicals.

See a spa dealer for guidance and recommendations on spa chemicals and supplies needed, as water chemistry varies from region to region. Various chemicals often sold under brand names, but a spa dealer can advise you on generic chemicals that are often less expensive than proprietary brands.

### Balancing the Total Alkalinity (TA)

Total Alkalinity is a measure of the total levels of carbonates, bicarbonates, hydroxides, and other alkaline substances in the water. TA is referred to as the water's "pH Buffer". In other words it's a measure of the ability of spa water to resist chemical changes in the pH level.

If the TA is too low, the pH level will fluctuate widely from high to low. Fluctuations in pH level can cause corrosion or scaling of the spa components. Low TA can be corrected by adding sodium carbonate (pH/Alkalinity Up).

If the total Alkalinity is too high, the pH level will tend to be high, and may be difficult to bring down. It can be lowered by using sodium bisulfate (pH/Alkalinity Down).

Once the TA is balanced, it normally remains stable, although the addition of more water with a high or low alkalinity will raise or lower the TA reading of the water.

When the Total Alkalinity is within the recommended range. Proceed to the next step.

### Balancing the Calcium Hardness (CH)

Calcium Hardness is a measure of the total amount of dissolved calcium in the water. Calcium helps control the corrosive nature of spa water, that's why Calcium - low water (Soft Water) is not recommended. It is very corrosive to the equipment and can cause stains in the spa shell.

If the CH is too high (Hard Water) formation of scale on the spa shell & surface can result. You can use a generic calcium remover to remove hardness from water. CH can also be decreased by dilution (75% Hard water, 25% Soft water) will usually yield a reading within the correct range. If soft water is not available or practical for you, a stain and scale inhibitor should be added to the spa water, according to label instructions.

If the CH is too low, add CH Increaser.

Once the CH is balanced, it normally remains stable, although the addition of more water with a high or low calcium content will raise or lower the CH reading of the water.

When the CH is within the recommended range proceed to the next step.

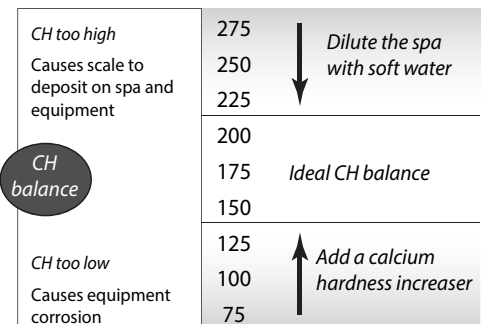
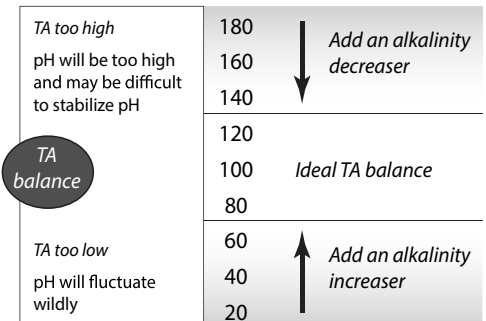

## Balancing the pH

The pH level is the measure of acidity and alkalinity. Values above 7.8 are alkaline; those below 7.2 are acidic. Maintaining the proper pH level is extremely important for optimizing the effectiveness of the sanitizer, maintaining water that is comfortable for the user, and preventing equipment deterioration.

If the spas water's pH level is too low, the following may result:

The sanitizer will dissipate rapidly

- The water may become irritating to spa users
- The spas equipment may corrode
- Bacteria and algae spikes can occur.

If the pH is too low it can be increased with sodium hydrogen carbonate (pH/Alkalinity Up) to the spa water.

If the pH level is too high, the following may result:

- The sanitizer is less effective
- Scale will form on the spa shell surface and equipment
- The water may become cloudy
- The filter cartridge may become obstructed.

If the pH is too high, it can be decreased by adding sodium bi-sulfate (pH/Alkalinity Down) to spa water.

**Note: After adding sodium hydrogen carbonate or sodium bi-sulfate, wait two hours before testing the spa water again for pH. Compounds take time to fully dissolve into the spa water, initial reading may not be accurate**

Its important to check the pH on a regular weekly basis. The pH will be affected by the bather load, the addition of new water, the addition of various chemicals, and other sanitizer used. When the pH is within the recommended range, proceed to begin the sanitation process.

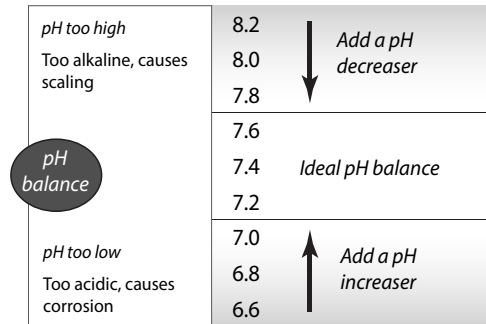

## Sanitation and Shock

Sanitizers kill bacteria and other organic waste by breaking them down to non-harmful level which are filtered out. Before you fill your spa, you need to decide which chemical sanitizer you wish to use. Consult your Cal Spas dealer for the right decision with regards to your lifestyle and spa usage.

**We recommend granulated chlorine or bromine as your sanitizer.** Both work well when maintained regularly

**Note: DO NOT USE Trichlor. Trichlor is very acidic and the hot temperature of the spa causes it to dissolve too fast, it will cause damage to your spa and will void your warranty.**

Whichever chemical you decide to use, do not take shortcuts. It will provide you with clean, safe, clear, spa water with a minimum of effort. Spa owners with an ozonator still need to use a chemical sanitizer. Whenever you test chemical levels, your test strip will likely have a test for chlorine or bromine. Make sure you sanitizer falls within the range shown on the next page.

Whenever you test your chemical levels, your test strip will likely have a test for chlorine or bromine. Make sure your sanitizer falls within the range shown on the next page.

**If your spa is equipped with a ozonator, this will assist in breaking down organic material and odors, but it will not disinfect your water, following the standard ppm recommendation for the sanitizer of choice is mandatory.**

## Starting & Maintaining Sanitizer Levels

*After you choose a sanitizer, you will need to establish a baseline and maintain it regularly.*

Sanitizing your spa with chlorine or bromine is very similar. Each sanitizer has its advantages and disadvantages. Sanitizer helps neutralize bacteria that can cause illness and other organic matter.

**Bromine:** Creates less odor and skin irritation than chlorine, bromine is less likely to do so. Additionally, unlike chlorine when bromine combines with bather waste and other contaminants in the water it remains an effective sanitizer. Bromine is also far less pH dependent than chlorine. Always remember that bromine itself is not a sanitizer, it needs to be activated with a bromine shock chemical in order to be effective, speak with your spa dealer for more information.

**Chlorine:** The most commonly recognized sanitizer is chlorine. However, the effectiveness of chlorine depends heavily on the pH level of the spa water. In order to get the most effective and economical benefit of chlorine, you must maintain a consistent pH level of between 7.2-7.6; a disadvantage of using chlorine is that when chlorine combines with bather waste and other contaminants, not only does it lose its sanitizing ability, it can cause odors and irritate eyes and skin to individuals with sensitive skin or prolonged spa exposure.

Testing For:	Ideal Range (ppm)	
	Minimum	Maximum
Chlorine Level	3.0 - 5.0	
Bromine Level	6.0 - 11.0	

***Note: If you choose to use bromine or chlorine we do not recommend the use of a floater. You have more control over the sanitizer levels by adding sanitizer as needed. Chemical abuse will void your warranty. When adding sanitizer to your spa, ensure that pump one is operating at high speed, and feed the sanitizer into the filter canister with the most suction, for spas with more than one pump we recommend activating all pumps for at least 10 minutes when adding sanitizer.***

Starting with fresh water/pre-filtered well water:

- Establish a baseline by adding either granulated chlorine or bromine.
  - Use a half ounce of chlorine for every 500 gallons of water
  - Use half an ounce of bromine for every 100 gallons
- Run the Jets for 10 minutes (Press/toggle the pump 1 button/icon)
- Test the water, make sure the pH, TA, and CH levels all fall within the ranges shown in the previous pages, make adjustments as needed.
- After balancing the water, if you are using bromine to sanitize your spa, you must activate your bromine. You will need to shock-oxidize the bromine inside of your spa. Depending on the size of your spa, usually you must add one to two ounces of shock, refer to the instructions inscribed in your chemical of choice.
- Test the water again, when the water is balanced, your spa is ready to use.

## Shocking the Water

In addition to using a chemical sanitizer, you will periodically need to shock the water. Shocking the water helps remove burned-out chemicals, bacteria, and other organic material from your spa's water and improves your sanitizer's effectiveness.

Do not use chlorinating shock, which can damage the spas jets and pump seals. Only use Oxidizer shock. It can be used with either bromine or chlorine sanitizers.

Add two ounces of oxidizer shock per 500 gallons once a week, after heavy bather loads, or if the water has a strong odor. The spa must be running with all of the jets on high for 30 minutes with the cover open. If necessary repeat the oxidizer shock in 30 minute intervals.

## Filtration & Cleaning

The filter is the part of your spa that removes big and microscopic debris from the water to maximize your spas water clarity. Regular maintenance must be done to maximize the spas filtering performance and heat efficiency.

**It is extremely important that you never run the spa without a filter, there is a possibility that debris may be sucked into the plumbing, damaging the spa pumps and heater.**

## Cleaning the Filter

In addition to spraying the filter down with a hose to remove surface debris, the filter must be deep cleaned every so often to dissolve scale and particles that are trapped within the pleats of the filter. Even if the filter looks clean, scale and other particles hide deep within the filter fibers restricting water flow. If the filter is not properly cleaned this will cause flow issues within the spa heater creating a heater malfunction. We recommend cleaning your filter at least once a month or every two weeks depending on spa usage.

Cleaning the filter

1. Remove the filter by unscrewing the filter counterclockwise from the top of the filter, do not use excessive force when removing or installing the filter.
2. Place the dirty filter into a bucket of water where the filter is completely submerged in water. Add the desired filter cleaner of choice, on average most manufactures recommend 8 ounces of chemical cleaner, verify the amount used on your chemical instructions.

**Note: It is recommended to obtain a spare filter to use in the spa when performing maintenance on the dirty filters. This way you can rotate the filters and extend their lifespan.**

3. Soak the filter for a minimum of 24hrs
4. Spray the filter with a water hose, with careful attention between filter pleats.
5. Reinstall the filter, Do not over-tighten.

## UV Light Water Treatment

In some Cal Spa models an optional UV light could be purchased to assist in sanitizing your spa. The UV light is always operating in the background whenever the spa is powered on. This UV light assists the disinfection of your spa by breaking down viruses and bacteria that could linger in the spas water. The UV light works in tandem with your regular sanitation regiment.

## General Water Care Schedule

<b>Prior to each use</b>	Test the spa water. Adjust chemical levels as necessary. Shock the water by adding ½ teaspoon of sodium dichlor per 250 gallons or 1 teaspoon of MPS per 250 gallons.
<b>After each use</b>	Add an ounce of oxidizer after heavy bather loads
<b>Once a week</b>	Check the filter well and inside the filter pipe for leaves and foreign matter. Test the spa water. Adjust chemical levels as necessary. Shock the water by adding ½ teaspoon of sodium per 250 gallons or 3 teaspoons of MPS per 250 gallons. If your water source is high in calcium, add stain and scale preventer.
<b>Every two to four weeks</b>	Deep clean your spa's filter. How often you clean your filter depends on how much you use your spa. There is no harm in frequently cleaning your filter and will only help your spa's efficiency.
<b>Every two to four months</b>	Change the spa water. How often you change the water depends on how much you use the spa. When you change the water, you will need to: <ul style="list-style-type: none"> <li>• Clean and polish the acrylic surface</li> <li>• Clean and treat the spa cover and pillows</li> <li>• Deep clean the filter</li> <li>• Refill your spa</li> </ul>
<b>Each time you refill the spa</b>	Follow the section "Filling and Powering Up Your Portable Spa"

## Generic Names for Chemicals

Water Chemistry		
Common name	Usual chemical name	Common brand names
pH Up	sodium hydroxide	pH Increaser, pH Up, pH Plus, pH Booster
pH Down	sodium bisulfate sodium bicarbonate (baking soda) sodium carbonate	pH Decreaser, pH Down, pH Minus, pH Subtracter, Dry Acid
Alkalinity increaser	sodium carbonate sodium bicarbonate (baking soda)	Alkalinity Increaser, Alkaline Up
Alkalinity decreaser	sodium bisulfate	Alkalinity Decreaser, Alkaline Down
Calcium increaser	calcium chloride	Calcium Increaser, Calcium Up, Calcium Plus, Hardness Increaser
Calcium decreaser	N/A To decrease calcium hardness, drain several gallons of water from the spa and refill using a mixture of 75% hard water and 25% soft water, or use a stain and scale inhibitor.	



Sanitizers		
Common name	Usual chemical name	Common brand names
Chlorine	sodium dichlor	Both chlorine and bromine are available under numerous brand names
Bromine	sodium bromide	

Shock		
Common name	Usual chemical name	Common brand names
MPS	monopersulphate	MPS Shock, Oxy-Spa, SeaKlear
Dichlor	sodium dichlor	Dichlor Shock

**Note:** Dichlor (chlorine) is both a sanitizer and a shock. Monopersulphate (MPS), when used as a shock, can be purchased alone as non-chlorinated shock or combined with dichlor, which makes it significantly more effective than MPS alone.

Other chemical additives		
Common name	Usual chemical name	Common brand names
Stain and scale inhibitor	These are usually proprietary chemical formulations and cannot be purchased as a single generic chemical.	Metal Stain Gone, Scale Inhibitor, Stain and Scale Preventer, Stain and Scale Defense
Foam inhibitor		Foam Gone, Foam Down, Defoamer
Clarifier		Water Brite, Spa Bright, Water Clarifier, Clear Water, Natural Clarifier, Brite & Clear

**Do NOT use these in your spa:**

- Sodium hypochlorite (household bleach)
- Trichlor

## Common Water Chemistry Questions

**Question :** Why is the use of a floater not recommended to sanitize my spa water?

**Answer:** We do not recommend the use of a floater for three reasons:

- The floater is unable to control the rate at which the sanitizer is dissolved into the water. When a floater is placed into a spa the sanitizer levels inside the spa can be extremely high. High sanitizer levels over a period of time will cause chemical burns and discolor the spa shell, jets, pillows, and spa cover underside. The use of floaters tends to lead to negligence of spa water sanitizer levels as well. Once the sanitizer is all dispensed and the floater is not checked daily, the low sanitizer level will allow viruses, algae and harmful bacteria like Legionella (Legionnaires disease) and E-Coli to grow.
- Floaters tend to stay in one area of the spa most of the time, causing this area to be exposed to extreme sanitizer levels. Most commonly a floater will become trapped near the filter weir or a seat, causing chemical damage to the section of the spa.
- The floater may allow small chunks or pieces of the concentrated sanitizer to fall out of its housing causing the chunks to settle at the bottom, causing pitting or chemical blisters to the spa shell. For this reason we advise you to use granulated chlorine or bromine as granulated sanitizers are designed for dissolve quickly inside of the spa with your jets activated. Chemical abuse is not covered under the terms of the limited warranty.



## Bather Load

“Bather Load” is the term used to describe the number of people using a spa, combined with the length of usage, and the frequency of usage. All these factors have a great effect on the spa water. The higher the bather load, the more chemicals need to be added and a longer filtration time will be needed.

Recommendations are designed for spas with average bather load (3 to 4 people, 15 minutes of usage, three times a week at 100 degrees). If your bather load exceeds these guidelines, and you experience water quality problems, increase the amount of filtration first, (go to the next higher filtration number) then if water quality is still not adequate, consult the advice of your Cal Spas dealer for additional chemical or system recommendations. Be sure to give them your bather load information.

## Ozonator

The ozone generator releases ozone into the spa water. You will still need to test for chlorine/bromine and occasionally replenish it to return the sanitizer level back to baseline. **For spas without a circulation pump, “Pump 1” will run at low speed and the ozonator will run during filtration.**

The spa’s control system is factory programmed with one filter cycle that will run in the evening, aligning with lower energy rates in that time slot. The time and duration of the filter cycle can be set according to your needs. In addition, a second filter cycle can be enabled. Filtration time may need to be increased with a heavy bather load.

Make sure water diverter valves are turned all the way to the left or right, and never left in the center position during filtration cycles. When the diverter valve is in the center position, there is not enough suction from the pump in order to inject ozone into the spa. The ozonator will generate ozone, but it would not be injected into the water effectively.

## Troubleshooting Water Clarity

Problem	Probable Causes	Possible Solutions
Cloudy Water	<ul style="list-style-type: none"> <li>• Dirty Filter</li> <li>• Excessive oils/ Organic matter</li> <li>• Improper sanitation</li> <li>• Suspended particles/organic matter</li> <li>• Overused or old water</li> </ul>	<ul style="list-style-type: none"> <li>• Clean filter</li> <li>• Shock spa with sanitizer</li> <li>• Add sanitizer</li> <li>• Adjust pH and/or alkalinity to recommended range</li> <li>• Run jet pump and clean filter</li> <li>• Drain and refill spa</li> </ul>
Water Odor	<ul style="list-style-type: none"> <li>• Excessive organics in water</li> <li>• Improper sanitation</li> <li>• Low pH</li> </ul>	<ul style="list-style-type: none"> <li>• Shock spa with sanitizer</li> <li>• Add sanitizer</li> <li>• Adjust pH to recommended range</li> </ul>
Musty Odor	<ul style="list-style-type: none"> <li>• Bacteria or algae growth</li> </ul>	<ul style="list-style-type: none"> <li>• Shock spa with sanitizer</li> <li>• Adjust pH to recommended range</li> </ul>

Problem	Probable Causes	Possible Solutions
Organic Buildup/ Scum Ring Around Spa	<ul style="list-style-type: none"> <li>Buildup of oils and dirt</li> </ul>	<ul style="list-style-type: none"> <li>Wipe off scum with clean rag - if severe, drain the spa, use a spa surface and tile cleaner to remove the scum and refill the spa</li> </ul>
Algae Growth	<ul style="list-style-type: none"> <li>High pH</li> <li>Low sanitizer level</li> </ul>	<ul style="list-style-type: none"> <li>Shock spa with sanitizer if problem is visible or persistent, drain, clean and refill the spa</li> </ul>
Eye Irritation	<ul style="list-style-type: none"> <li>Low pH</li> <li>Low sanitizer level</li> </ul>	<ul style="list-style-type: none"> <li>Adjust pH</li> <li>Shock spa with sanitizer and maintain sanitizer level</li> </ul>
Skin Irritation/ Rash	<ul style="list-style-type: none"> <li>Unsanitary water</li> <li>Free chlorine level above 5ppm</li> </ul>	<ul style="list-style-type: none"> <li>Shock spa with sanitizer and maintain sanitizer level</li> <li>Allow free chlorine level to drop below 5 ppm before spa use</li> </ul>
Stains	<ul style="list-style-type: none"> <li>Total alkalinity and/or pH is too low</li> <li>High iron or copper in source water</li> </ul>	<ul style="list-style-type: none"> <li>Adjust total alkalinity and/or pH</li> <li>Use a stain and scale inhibitor</li> </ul>
Scale	<ul style="list-style-type: none"> <li>High calcium content in water - total alkalinity and pH too high</li> </ul>	<ul style="list-style-type: none"> <li>Adjust total alkalinity and pH - If scale requires removal, drain the spa, scrub off the scale, refill the spa and balance water</li> <li>Use a stain and scale inhibitor</li> </ul>

## Chemical Abuse

Chemical abuse is defined as negligent/careless use of both recommended spa chemicals, and use of prohibited chemicals. The spa shell is designed to last for many years, but when the shell is exposed to excessive chemicals, or improper chemical application; this can cause reactions on the shell that can cause pitting, cracks, bubbling, and other blemishes on the shell.

Spa jets, pillows, and other components are designed to withstand sanitizer levels within the range mentioned in this manual. Excessive sanitizer use will cause oxidation of the interior of the spas metals and other components, which can cause rust/oxidation of jets, deterioration of spa pillows, speakers and plastics, and damage/oxidation of the spa cover.

Components & materials damaged by chemical abuse are not covered under warranty. Depending on the extent of damage the entire spa warranty can be voided, as stated in the limited warranty.

## Cleaning and Maintenance

### Removing and Re-seating Pillows

You can remove the pillows for cleaning and maintenance quickly and easily. This method works for all pillow types.

Grab the lower edge of the pillow with both hands and firmly pull up, as you do this the pillows inserts will pop out of the holes.

Re-seat the pillows by aligning the pillow inserts with the holes and striking the pillow hard enough for the insert pegs to pop back in place.



### Jet Removal and Replacement

Jets can be easily removed for cleaning.

Grasp the outer lip/rip of the jet and turn it counter-clockwise until it completely stops, you may feel the jet loosen and pop out a bit, pull the jet outward. The jet will be very snug and may require additional turning force to pop-out. **DO NOT PRY OUT JETS**

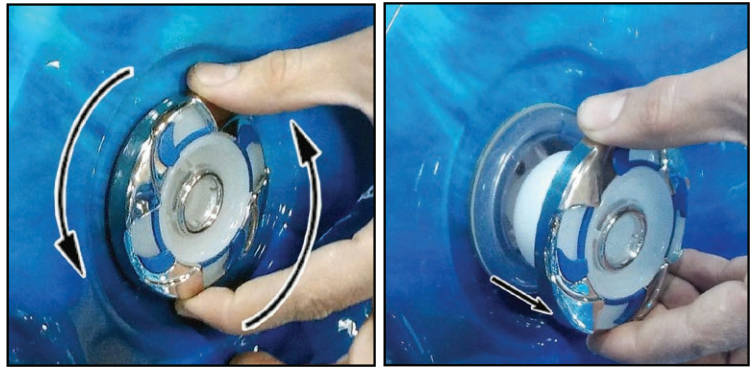

To replace the jet, place it in the fitting and turn clockwise until it click into place and can be rotated freely to open and close water flow again.

*Note: have the jets turned off when removing jet inserts, it will be easier to remove when there is no water flow through it.*

### Cleaning the HydroStreamers

To ensure proper flow through the hydrostreamers, follow this maintenance process should any jet(s) have diminished flow.

**Step 1.** Turn the jet counter-clockwise to remove the chrome jet head.

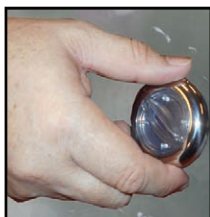

**Step 2.** Pull the chrome cap off.



**Step 3.** Pull the plastic jet opening and its gasket off.



**Step 4.** Pull out the inner plastic filter.



**Step 4.(2)** The plastic filter is shown completely removed from its housing



**Step 5.** Tap the filter and/or blow out the debris to ensure all holes are clear.



**Step 6.** Slide the plastic filter back in the Jet.

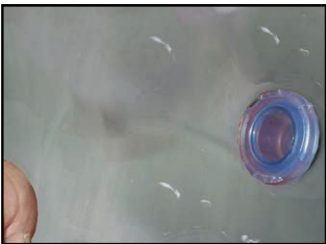

**Step 7.** Re-insert the gasket into clear plastic spout.



**Step 8.** Place the gasket into the plastic spout and then insert the spout into the jet body.



**Step 9.** Insert the plastic spout into the jet body.



**Step 10.** Place the chrome ring cap back on and turn clockwise to tighten it down.



## Spa Cover and Locking System Installation

The spa cover can be considered one of the most important parts of your spa. The spa cover helps retain the heat inside of your spa in all different types of weather. The cover works as a lid on a thermos, when the spa is not in use the cover helps lower the amount of time the spas heater has to run for. Using the cover will help lower your operating cost of your spa when the spa is not in use.

**Note: The cover is constructed of rigid foam and metal, but it is not meant to support weight for your safety, do not sit, stand, or lie on the cover, nor should you place objects on top of the spa cover**

- Covered spas will protect your spas finish from the suns ultraviolet rays.
- You are required to use the spa cover to maintain warranty coverage.
- Covering your spa prevents children or pets from drowning in your spa.

**Step 1** Place cover on spa. Make sure it is correctly positioned, with the skirt of the cover wrapping over your spa shell. This helps prevent blistering and cracking from sun exposure.



**Step 2** Position the tie-down hardware (attached to the straps of your cover) on the side of the spa so they are easily reached by the cover tie-down straps.



**Step 3** With the straps pulled tight (but not overly tight), lightly pre-drill the location for screw placement. Gently drill 3 holes - one for each screw slot in the lock.

**Note:** Use a low torque drill, or use the lowest setting on your drill, do not drill in the screw all the way as the corners are designed with an air pocket inside to retain heat inside of your spa. Too much force may deform the shape of the corner and would not look as appealing.

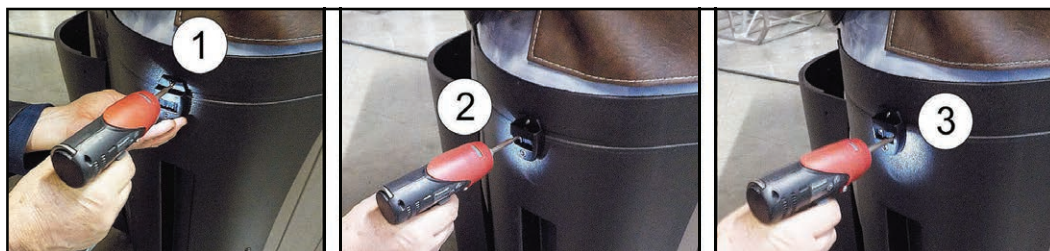

**Note:** Illustrated corners may appear differently to the ones on your spa.

**Step 4**

Use a screwdriver to finish screwing in the three screws, repeat this process for the remaining 3 corners.



**Step 5**

Keep the cover fastened down at all times when not in use, locking hardware may be locked with a key (provided in the packaging of the spa cover)



**Step 6**

The provided key will allow you to lock down your spa cover. We recommend locking your spa cover when the spa is not in use. Store your key somewhere safe, away from children.



**WARNING**  
**AVOID**  
**DROWNING**  
**RISK**

**FAILURE TO FOLLOW INSTRUCTIONS MAY RESULT IN INJURY OR DROWNING  
NON-SECURED OR IMPROPERLY SECURED COVERS ARE A HAZARD.  
REMOVE COVER COMPLETELY BEFORE ENTRY OF BATHERS.  
ENTRAPMENT POSSIBLE.  
KEEP COVER ON SPA AND LOCKED WHEN NOT IN USE**

## Draining Your Portable Spa

Your spa should be drained every four to six months, for cleaning and maintenance. This interval for most swim spa owners is every 6 months, as swim spas have more water volume compared to a regular hot tub. Every time the spa is emptied it must be filled with fresh tap water. Avoid leaving your swim spa empty of water. Before you begin turn the power off to the spa at the breaker and remove your filters, perform filter maintenance as well to not introduce contaminants in your new spa water.

**Note - For Olympian swim spas, the small spa side should be drained and filled every 2-3 months. This interval is based on bather load and water testing information, unique to each spa owner.**

### Step 1. Locate Your Drain

Pull the knob out of the cabinet. The cabinet drain is screwed into the drain pull knob.



### Step 2. Remove the cap

Make sure the valve is in the closed position, then unscrew and remove the cap.



### Step 3. Connect Valve to a Hose

Attach a garden hose to the hose-bib fixture. Place the other end of the garden hose where you would like the water to drain too.

### Step 4. Drain the Spa

Turn the valve on the hose-bib fixture to open the drain. When the spa has drained completely, turn the valve on the hose-bib fixture, remove the hose and replace the cap.



## Winterizing (Cold Climate Draining)

Depending on your region in your country, the temperature could drop below 32F(0°C). If you are one of those regions, we recommend that you always have your spa full of water and running at normal spa temperatures between 80°F - 100°F (26.7°C - 37.8°C). This will help reduce the risk of water freezing in your spa and inside of the spa equipment.

**WARNING: If you find the need to drain your spa, be aware of the potential risk of water freezing in your spas equipment and plumbing, even if the directions below are followed perfectly, there is no guarantee that your spa will not suffer freeze damage. Freeze damage is not covered under warranty.**

- 1 - Open all filter covers.
- 2 - Remove the filter baskets and filters
- 3 - Drain your spa completely.
- 4 - Vacuum water from the spa's main drain fitting with a wet/dry vacuum
- 5 - Open the bleeder valves on the pumps
- 6 - For spas equipped with a UV light, loosen the quarts tube nut to let the water drain from the UV light chamber.
- 7 - Disconnect the unions from both sides of the pump.
- 8 - Blow out any remaining water out of the jets, suctions, filter canister, and equipment area with a wet/dry shop vac.
- 9 - When it has completely finished draining, replace the quarts tube in the UV lamp chamber, and tighten the nut. Close the bleeder valves and re-connect the unions on the pumps.
- 10 - Replace the filter basket and filters.
- 11 - Cover your spa with a good spa cover and an all weather tarp to ensure neither rain nor snow enters the spa.



**Note: Do not use antifreeze to treat your spa, irreversible damage will occur to seals and spa finish.**

## Cleaning and Replacing the Filter

Filtration is one of the most important steps you can take to ensure clean, clear water. It is far less expensive to fix water clarity problems by properly filtering your spa than using excessive amounts of chemicals, excessive filtration times, or by water replacement.

## Vacation Care

You can leave your spa unattended for up to two weeks if you follow these instructions

**Note: Always lock your spa cover using the cover locks if you plan to be away from home and the spa is filled with water, these instructions will help maintain your water quality for up to two weeks. Use of the spa during this period of time by guests or family can affect the clarity and conditions of the spa.**

Select a low range temperature of 80F (27C)

*Note: Spas with Gecko systems, Refer to filtration mode "Away From Home" in the control panel section of the manual.*

- 1. Use a test strip, Adjust pH, AK, and CH if necessary.
- 2. Shock the spa water with your selected sanitizer (Add either bromine or chlorine)
- 3. Lock the spa cover to the cover locks.
- 4. When you return, test the water again and adjust pH and shock the water again.

If you will not be using your spa for longer than 14 days and the spa is not able to be maintained, we recommend following the cold climate procedure to prevent algae growth, bacteria, and spa damage.

## Cleaning Your Spa

### Spa Cover and Pillows

Due to constant punishment your spa cover and pillow receive, you should protect them by applying a vinyl and leather cleaner as part of your monthly maintenance plan. Use a product that is designed specific to spa covers and pillows, to protect them from UV ray damage without leaving an oily residue. Contact your spa dealer for recommendations.

**Warning DO NOT use any kind of automotive vinyl protectants on spa pillows or covers (ex. Armor all, Meguiar's, etc). These products are oil based and will leave an oily layer on your water line and will cause severe water clarity issues that require hours of work to correct, including multiple flushes of the system.**

### Spa Shell

Each time the spa is drained, before the spa is refilled it should be cleaned with an all purpose cleaner, or a mild detergent, followed up with a surface protectant. Do not use abrasive chemicals or cleaning tools as it may scratch the acrylic. Use a non oil based protectant designed for spas to protect the finish from mineral build up associated with normal spa use.

## Using the Freedom Sound System

The Freedom Sound System™ entertainment option contains a Bluetooth enabled speaker system that is available for certain Cal Spa models. Any Bluetooth-enabled device can be used to play audio through your spa. Before you can use the sound system, you will need to pair the speakers to your smart device via Bluetooth. The Freedom Sound System will respond to equalizer (EQ) from your mobile device, use your devices settings to adjust bass, treble, or certain frequencies you wish to amplify.

On your mobile device, open the settings and select Bluetooth, the device will begin to scan for available devices. Bluetooth signal is the strongest when you are next to the spa with a range of 5-10 feet based on conditions and the position of the spa.

**The sound system will appear as “Aquatic AV” on your mobile device.** Apple devices may require a password to pair, use “0000” to pair the spa to your device. Android devices will pair at initial selection from your devices Bluetooth menu.

Once your device is paired and connected, all sounds from your device will be played through the sound system, including system sounds and telephone.

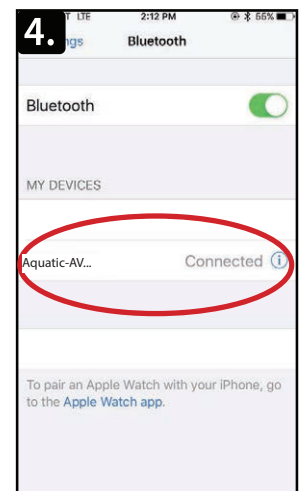
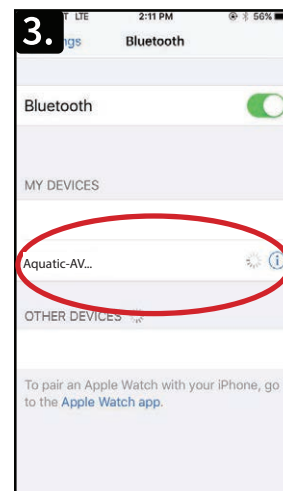
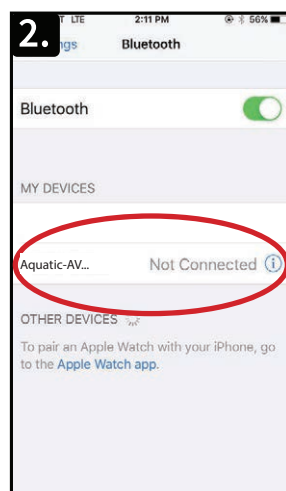
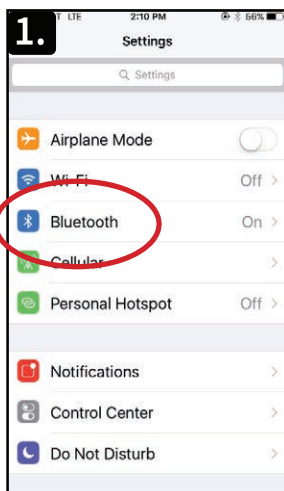

## Working Out with Your Swim Spa

### Air Injection/Resistance

Use the control panel to start and stop jets, and use the air venturis at the end of the swim spa next to the main hand rail of the swim spa to inject air into the swim jets. When air is introduced to the spa jets, water resistance increases, giving you the ability to have more vigorous exercise. You may also adjust the angle of the main swim jets to push water upward or lower to increase buoyancy and resistance.

### Swim Tether

The swim tether pole has three pieces and assembles easily. slide the ends of the top and middle sections into the middle and bottom sections.

Insert the tether in the anchor hole when you are read to use it. Buckle the strap around your waist, it is easily adjustable and can accommodate most sizes as its designed as a one fits most.

### Exercise Equipment

#### Optional Add on Item\*\*

**Important:** Always consult your physician before starting any exercise activity or fitness program, the exercise equipment is designed for resistance training using elastic bands. When these bands are stretched the bands are under high tension. Improper use or failure to connect the exercise equipment can lead to injury, under high tension these bands can snap back towards the user or to others in or near the spa. Always inspect all of the exercise equipment and their connections before beginning any exercise. Never use any damaged equipment, and only use this equipment for its intended purpose.

### Connecting the Exercise Equipment

The drawings starting on page 92 show the exercise kits placement in different spa models. Refer to the following pages to learn where the proper anchor points are within your swim spa.

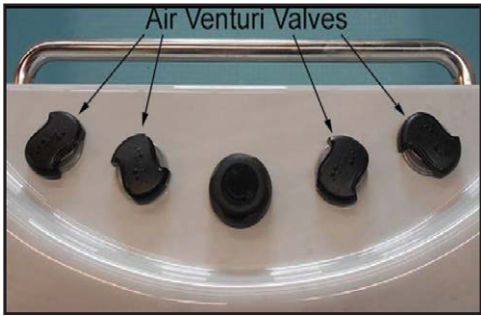

*\*\*For Illustration purposes, Diverters and Air Venturis style varies based on design choices through our continuous improvement program.*



#### For 14 foot spas including F1325, X

The exercise kit contains

- Two hand grips
- Two 6" elastic bands
- Two 18" elastic bands
- Two 25" elastic bands
- Two rowing bars

#### For 16 and 17 foot spas

The exercise kit contains

- Two hand grips
- Two 18" elastic bands
- Two 25" elastic bands
- Two 56" elastic bands
- Two rowing bars.

## Anchor Points for Fitness Straps

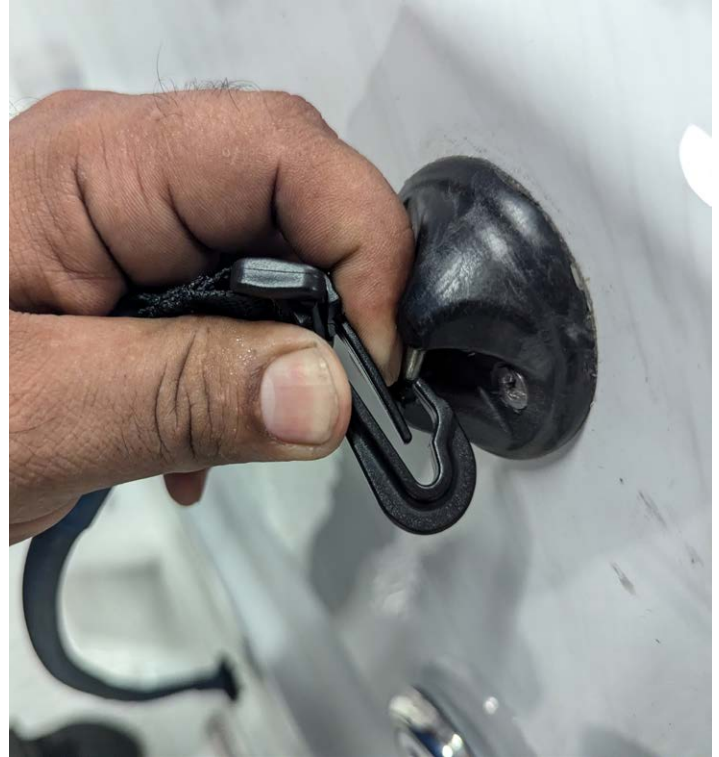

There are several different anchor points within your swim spa. These anchor points can be used to install fitness equipment including the row bars and fitness straps. All equipment within the fitness equipment pack uses plastic clips or metal hooks.

Swim spas are not included with fitness equipment, this is an add-on accessory. You can purchase this equipment from your dealer, or from our website at [www.quickspaparts.com](http://www.quickspaparts.com).



**Note:** When attaching the row bar align the row bar to hook towards the front of the spa. These row bars slide onto the anchor point by lining up the row bar into the anchor, hook and slide it.

Hook the row bar with caution to avoid scratching the acrylic within your spa.

**Note:** When the fitness equipment is not in use, do not leave the elastic straps/bands, handles, or row bars inside of the spa. After each use dry the equipment with a towel and store within its provided duffel bag.

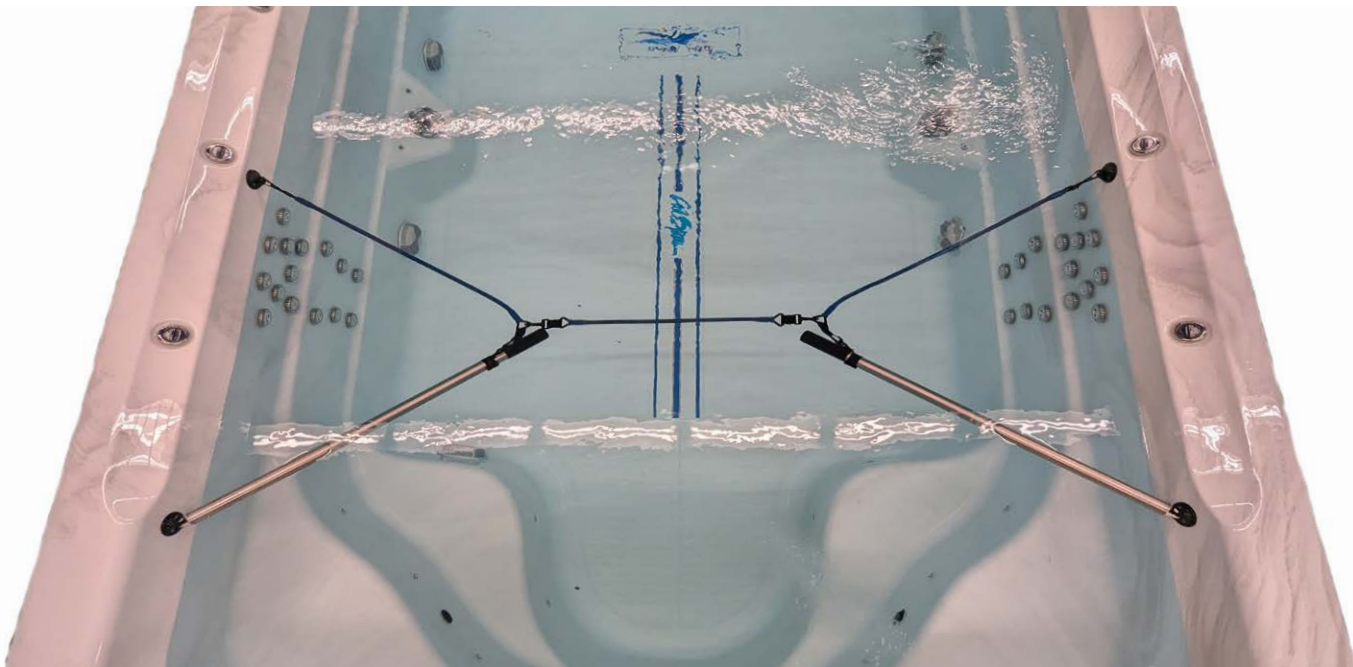

*For illustration purposes only\**

**Refer to pages 94-98 for proper placement of exercise straps/equipment**

The Fitness straps should be used to secure the row equipment in place. First secure the row itself with an anchor point, a 25" strap will be used on each side. The smallest 18" strap should be used to connect the two rows together.

**Note: Always be cautious when setting up the fitness equipment, the straps have tension once they are set in the row position, and have tension when used to do other warm up exercises.**



The kit is designed to do a variety of different stretches and exercises. The swim spa has multiple anchor points that can be used to suit a variety of desired exercises.

**Note: Always proceed with caution when using elastic bands, improper operation can snap the bands and cause damage to the spa or personal injury.**

# Anchor Points for Fitness Equipment

The diagrams below show where each of the anchor points are. Each point is circled within the diagram. These diagrams also show the expected position of each strap style

**Note:** The center anchor point is not circled. This is meant for a swim tether.



## F-1325X

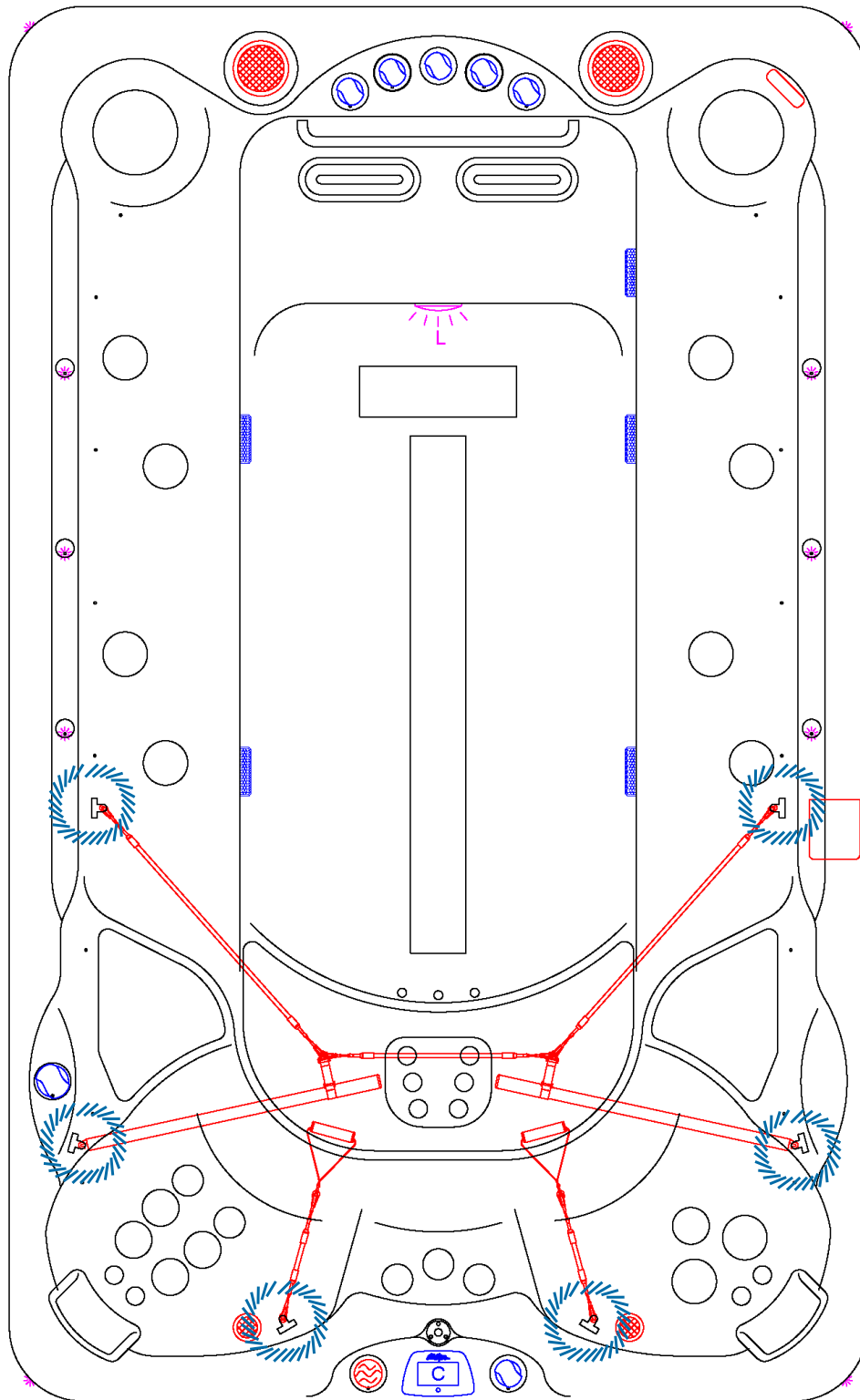

# F-1437X



= Anchor Point

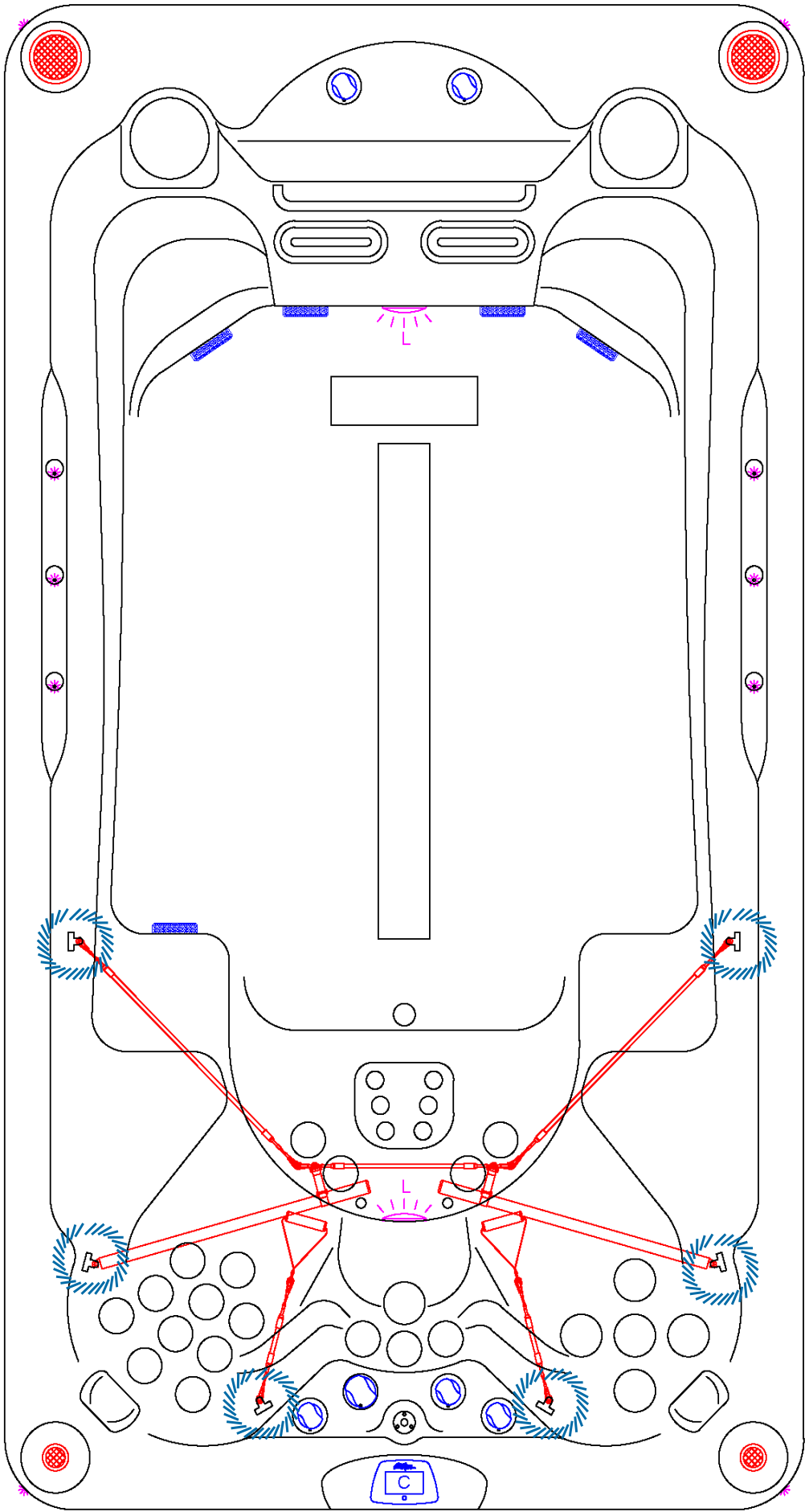

# F-1655X

 = Anchor Point

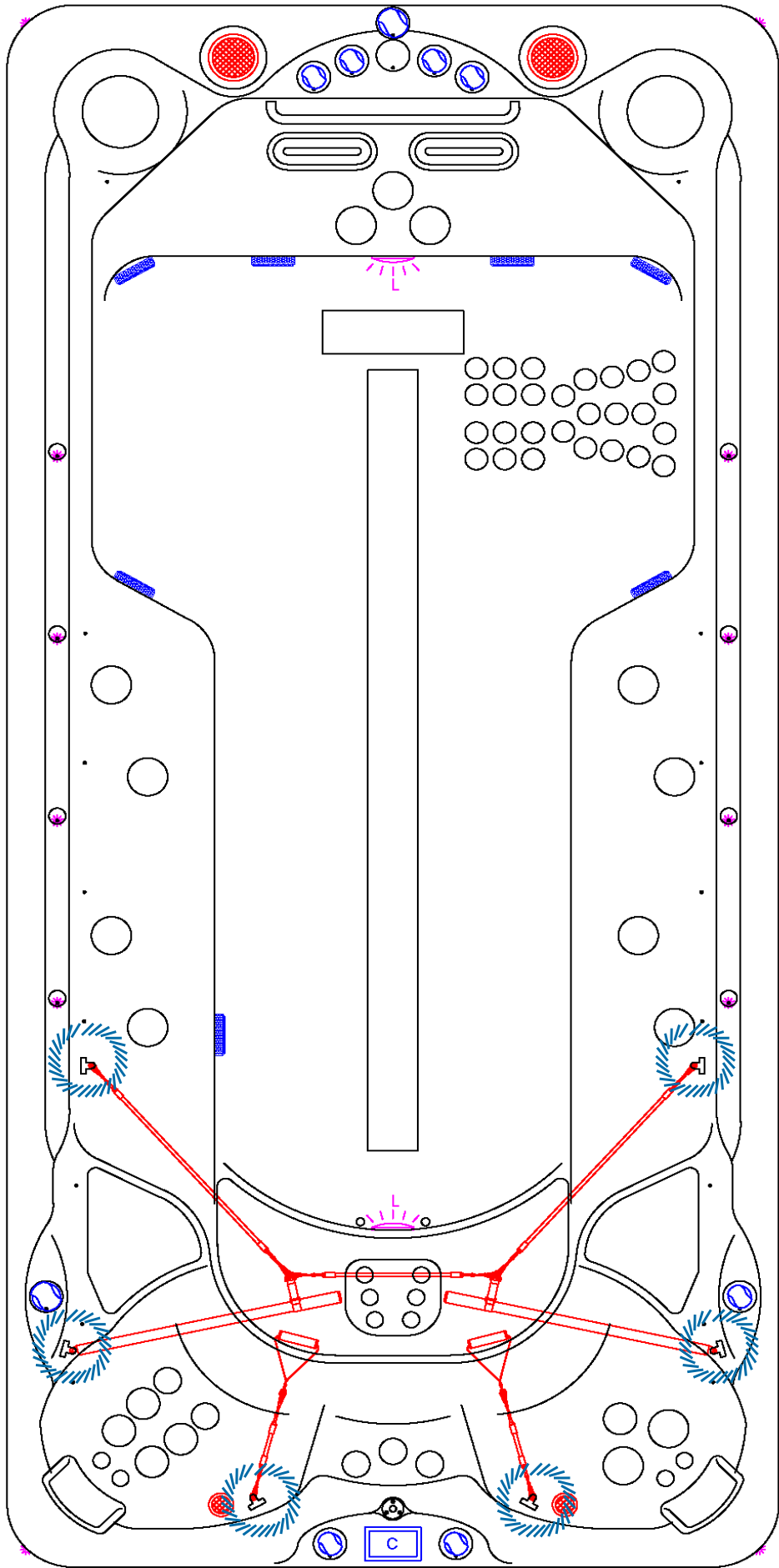



# F-1868DZ



= Anchor Point

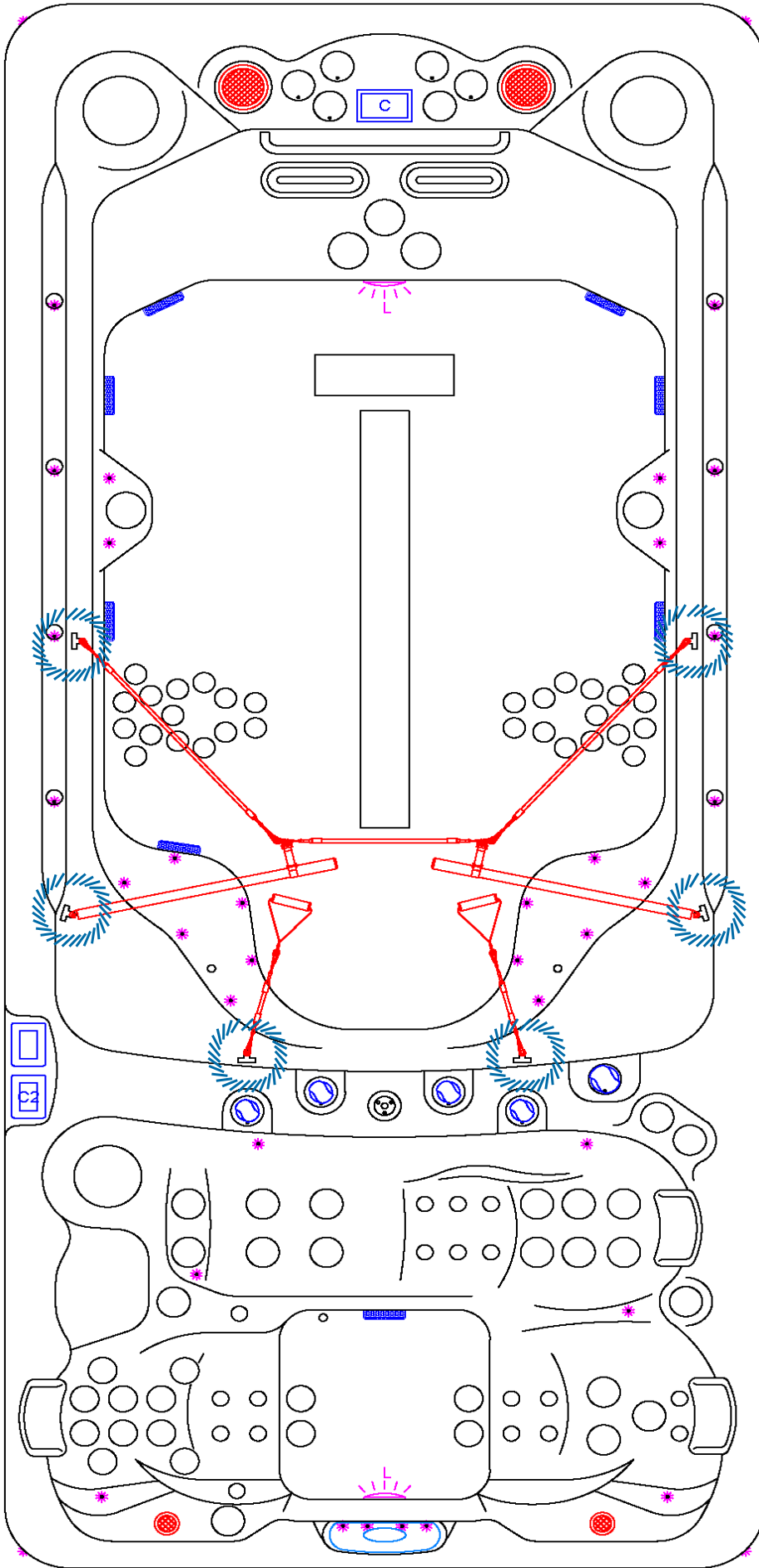

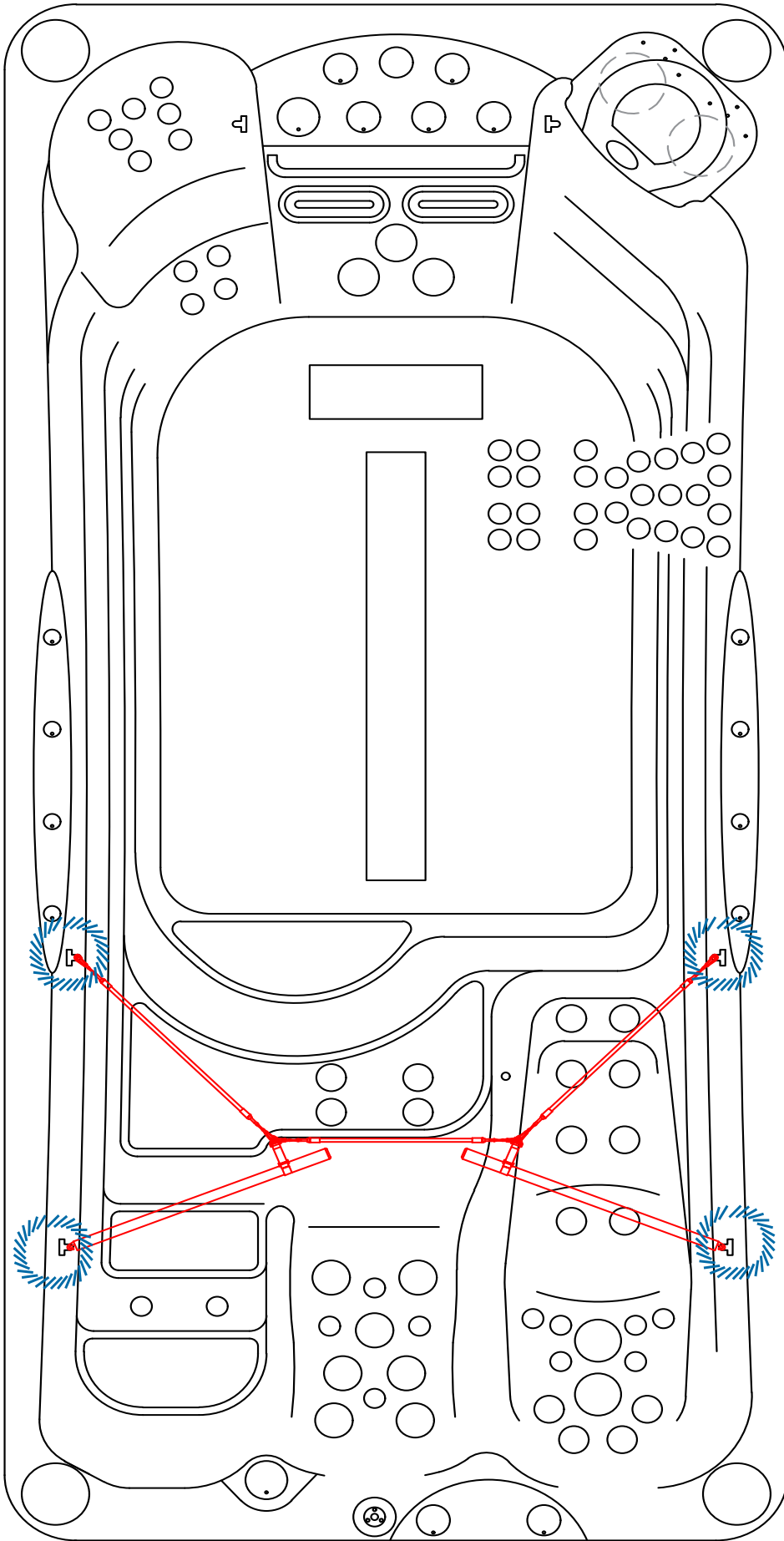

# F-1655X





 = Anchor Point



This Page is Intentionally Blank

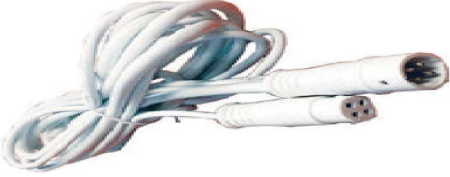

## Replacement Parts

<b>1 to 3 ext cord</b> LIT16100335	
<b>1 to 1 port ext cord</b> LIT16100338	
<b>Interior Light with Logic (7 LEDs)</b> LIT16100337	
<b>Interior Light without Logic (7 LEDs)</b> LIT16100333	
<b>Main Light Housing (LED Lens,grommet gasket)</b> LIT630-7048	
<b>Filter Cartridge 75 sqft</b> FIL517-4619LC-DSG	
<b>Filter Cartridge 50 sqft</b> FIL50-D13H15FCT-3	

<p><b>SGMS Teleweir Filter, 50 Sq. Ft. 6 Scallop, w/out Cartridge, 2" Check Valve, HLG (517-4609LC-HLG)</b></p> <p>FIL517-4609LC-HLG</p>	<p><b>FILTER UP-ANCHOR SKIMMER WHITE (Pantone PMS 2330C) (L-2124)</b></p> <p>FIL11700330</p>
<p><b>SGMS Ultra Skim Filter, 75 Sq. Ft. w/out Weir, with Cartridge, HLG (517-4619LC-HLG)</b></p> <p>FIL517-4619LC-HLG</p>	<p><b>3 Inch Jet Insert (3DR) Mini Storm Internal, Twister, Vector X Style HLG</b></p> <p>PLUCS2441049S-HLG</p>
<p><b>FILTER PLATE WHITE WITH CAL SPA LOGO EVA (L-4235)</b></p> <p>FIL11700331</p>	
<p><b>FILTER CARTRIDGE 50 SQFT,</b></p> <p>FIL11700338</p>	
<p><b>5 Inch Jet Insert Power Storm Internal, Roto, HLG Vector X Style, Metal, With O-Ring on Diffuser</b></p> <p>PLUCS2247049S-HLG</p>	
<p><b>5 inch Jet Insert - (5T) Adjustable Whirlpool Internal, Vector X Style, Metal</b></p> <p>PLUCS2394029S-HLG</p>	
<p><b>Cal Spas Cascade Pillow (Off White)</b></p> <p>ACC0140</p>	



<p><b>4.5 inch Jet Insert Poly Storm Internal, Waterway Roto E/B - HLG Vector X Style, Metal, With O-Ring on Diffuser</b></p> <p>PLUCS2446039SHLG</p>	
<p><b>4.5 Inch Jet Insert Poly Storm Internal, Turbine, HLG Vector X Style, Metal, With O-Ring on Diffuser</b></p> <p>PLUCS2446069S-HLG</p>	
<p><b>5 Inch Jet Insert (5D) Power Storm Internal, Metal Directional E/B - HLG Vector X Style, Metal, With O-Ring on Diffuser</b></p> <p>PLUCS2447009SSH LG</p>	
<p><b>5 Inch Power Storm Internal, Tri Directional E/B - HLG Vector X Style, Metal, With O-Ring on Diffuser</b></p> <p>PLUCS2447019SHLG</p>	
<p><b>5 Inch Jet Insert Power Storm Internal, Metal Twin Roto E/B, HLG Vector X Style, Metal, With O-Ring on Diffuser</b></p> <p>PLUCS2447049SSH LG</p>	
<p><b>5 Inch Jet Insert Power Storm Internal, Turbine, HLG Vector X Style, Metal, With O-Ring on Diffuser</b></p> <p>PLUCS2447069S-HLG</p>	
<p><b>Waterfall 12" LED Spill Over</b></p> <p>PLU21801038</p>	

<p><b>2 Inch Jet Insert (2D) Cluster Storm Internal, Directional, Vector X Style, Assy</b></p> <p>PLUCS2440019S-HLG</p>	
<p><b>5 inch Jet Insert - (5T) Adjustable Whirlpool Internal, Vector X Style, Metal</b></p> <p>PLUCS2440029S-HLG</p>	
<p><b>3 Inch Jet Insert (3D) Mini Storm Internal, Multi-Massage, Vector X Style, Metal, With O-Ring on Diffuser</b></p> <p>PLUCS2445059S-HLG</p>	
<p><b>3 Inch Jet Insert (3D) Mini Storm Directional Metal Eyeball Int. Vector X Style Assy</b></p> <p>PLUCS2445009SSH LG</p>	
<p><b>4.5 Inch Poly Storm Internal, Metal Directional E/B, Vector X Style, Metal, With O-Ring on Diffuser HLG</b></p> <p>PLUCS2446009SSH LG</p>	
<p><b>4.5 Inch Jet Insert Poly Storm Internal, Metal Roto E/B - HLG Vector X Style, Metal, With O-Ring on Diffuser</b></p> <p>PLUCS2446029SSH LG</p>	
<p><b>Cal Spas Y- Pillow (Off White)</b></p> <p>ACC01401102-W</p>	



<p><b>1 LED Light String</b></p> <p>LIT16100330</p>	
<p><b>2 LED Light String</b></p> <p>LIT16100331</p>	
<p><b>4 LED Light String</b></p> <p>LIT16100332</p>	
<p><b>Spa Cover Locks and Keys</b></p> <p>ACC01800026, ACC01800020</p>	
<p><b>Swim Jet. Rip Current Metal White</b></p> <p>PLU210-5168S</p>	
<p><b>Flush Mount, Coin Slot Hydro Streamer</b></p> <p>PLU210-8508S</p>	
<p><b>Round Power Stream Swim Jet</b></p> <p>PLU210-0838S</p>	
<p><b>Super Drain High Flow Suction</b></p> <p>PLU644-5419-HLGV</p>	
<p><b>Teleweir Filter Housing 6sclp</b></p> <p>FIL5174609LC-HLG</p>	



## Replacement of Cabinet Panels

The complete selection of replacement cabinets for all models is very extensive and too lengthy for this owner's manual. To order replacement panels for your spa, visit [www.quickspaparts.com](http://www.quickspaparts.com)

### Covers

All spa covers are designed with a tapered height, angling downward from the center to the sides to drive off rain and prevent water from pooling. The covers listed below are filled with either 1 lb, 1.5 lb, or 2.0 lb foam.



#### 93" x 141"

Fits spa models: F-1222

- COV93141DBK-3 Deluxe Taper Black
- COV93141DDB-3 Deluxe Taper Dark Brown
- COV93141DG-3 Deluxe Taper Gray

#### 93" x 171"

Fits spa models: F-1420, F-1437

- COV93171DBK-3 Deluxe Taper Black
- COV93171DDB-3 Deluxe Taper Dark Brown
- COV93171DG-3 Deluxe Taper Gray

#### 93" x 200"

Fits spa models: F-1640, F-1770

- COV93200DBK-3 Deluxe Taper Black
- COV93200DDB-3 Deluxe Taper Dark Brown
- COV93200DG-3 Deluxe Taper Gray

#### 93" x 210"

Fits spa model F-1896DL

- COV93210DBK-3 Deluxe Taper Black
- COV93210DDB-3 Deluxe Taper Dark Brown
- COV93210DG-3 Deluxe Taper Gray

#### 93" x 151"

Fits spa model F-1335

- COV93151DBK-3 Deluxe Taper Black
- COV93151DDB-3 Deluxe Taper Dark Brown
- COV93151DG-3 Deluxe Taper Gray

## Basic Troubleshooting

The troubleshooting guidance provided here is intended to cover the most common problems a spa owner may encounter. For more in-depth troubleshooting, go to [www.calspas.com/troubleshooting](http://www.calspas.com/troubleshooting).

Symptom	Possible Solutions
---------	--------------------

### Problems starting up

Pump won't prime	See priming instructions
Breaker keeps shutting off	Reset the GFCI breaker. If this continues, contact your dealer or a qualified spa technician.

### Power and system problems

System won't start up or breaker keeps shutting off	Power may be shut off. Turn on GFCI circuit breaker. If this continues, contact your dealer or a qualified spa technician.
Control panel doesn't respond	Turn on or reset the GFCI circuit breaker. If this does not solve the problem, contact your dealer or a qualified spa technician. If you hear the pump running but the control panel doesn't respond, contact your dealer
Spa does not turn off	Spa may be trying to heat up. Check if spa is in Ready or Rest mode In cold climates, if spa is not equipped with full foam or any kind of insulation, it will try to maintain the set temperature. Set the spa to low temperature range and set the temperature to 80°F. Spa may be in filter cycle. If it is, this is normal and no adjustment is necessary.
Message on the control panel	There may be a problem. See Diagnostic Messages ▸

### Heat problems

Spa water does not get hot	Spa may be in low temperature range. Set the spa to high temperature range. The filter may be dirty or may need to be replaced. Clean or replace the filter. The water level may be too low. Fill the spa with water level at 4 to 6 inches from the top. The temperature is not turned up high enough. Raise temperature on topside control. Cover the spa. The cover will keep heat in the spa and help keep heat from escaping. Make sure cover is on at all times when spa is not in use. The heater element may be old, deteriorated, coated with scale, or defective. Contact your dealer for more assistance. The gate valves may be partially or completely closed. NEVER OPERATE YOUR SPA WITH THE GATE VALVES CLOSED!
----------------------------	---

Symptom	Possible Solutions
Spa overheats - temperature greater than 110°F / 43°C	<p>Overheating can occur during summer months and may not necessarily indicate a malfunction. When it occurs, a message code may also appear on the control panel.</p> <p>Temperature may be set too high. Turn the set temperature down to a lower temperature.</p> <p>Filtration time may be too long. Turn the filtration cycles down during the warm months.</p> <p>The spa may not be properly ventilated. Make sure the front of the spa is not blocked to allow air flow.</p> <p>High speed pumps may have been running too long. Limit pump running time to no more than 15 to 30 minutes.</p>

### Water pressure problems

Low water pressure	<p>Jet valves may be partially or fully closed. Open the jet valves.</p> <p>Filter cartridge may be dirty. Clean or replace the filter.</p> <p>Pump may have airlock. Remove airlock by priming spa</p> <p>The suction fittings may be blocked. Remove any debris that may be blocking them.</p> <p>The filter skimmer may be blocked. Remove the blockage.</p> <p>Gate valves may be closed. Open gate valves. Note: Never operate your spa with the gate valves closed!</p> <p>Spa may be running in filtration mode. Press JETS or JETS 1 button to turn on high speed pump.</p>
No water pressure (no water stream from any jets)	<p>Power may be switched off. Turn the power back on.</p> <p>The pump may be defective. After you have tried all other troubleshooting, contact your dealer for assistance.</p>
Jets surge on and off	Water level may be too low. Add water to normal level.

### Pump problems

Pump runs constantly – will not shut off	There may be a problem with circuit board. Contact your dealer.
Noisy pump	<p>The water level may be too low. Fill the spa with water level at 4 to 6 inches from the top.</p> <p>Filter cartridge may be dirty. Clean or replace the filter.</p> <p>Pump may have airlock. Remove airlock by priming spa</p> <p>The suction fittings may be blocked. Remove any debris that may be blocking the suction fittings.</p> <p>Gate valves may be closed. Open gate valves. Note: Never operate your spa with the gate valves closed!</p> <p>Air may be leaking into the suction line. Contact your dealer for assistance.</p> <p>Debris may be inside the pump. Contact your dealer for assistance.</p> <p>Noise may be a sign of damage. Contact your dealer for service.</p>

Symptom	Possible Solutions
Pump turns off during operation	Automatic timer may have completed its cycle. Press JETS or JETS 1 button to start the cycle again. Pump may have overheated due to the vents on the equipment door being blocked. Make sure the front of the spa is not blocked to allow air flow. The pump motor may be defective. Contact your dealer for assistance.
Pump has a burning smell while running	A burning smell may be a sign of damage. Contact your dealer for service.
Pump does not run	Pump may have over heated. Let it cool for an hour and try operating the spa for a shorter time. Power to the spa may be shut off. Turn on or reset the GFCI circuit breaker. If this does not solve the problem, contact your dealer or a qualified spa technician.

## “Thermal Creep”

Cal Spas are designed with energy-efficient components and systems that are meant to sustain heat generated by the equipment, which is then cycled back into the spa water. In hot weather or in situations where the spa is set to extended run times, Thermal Creep may occur. Thermal Creep is a condition where the measured water temperature can be higher than the set temperature. To manage Thermal Creep you may:

**Vent your cover.** This means placing a folded cloth about ¾” (2cm) thick under all four corners of the cover before you lock the cover down.

**Open your cover.** Opening the cover at night will also quickly cool the water down if desired.

**Open all air controls.** Set your filtration cycles to run during the cooler times of the day or night.

**Reduce the length of your filter cycles.**

**Visit your local dealer for additional guidance.**

Since Thermal Creep only occurs in well-insulated hot tubs, it is not indicative of something that is wrong with your spa or its equipment.

This Page is Intentionally Blank



## LIMITED WARRANTY

This Limited Warranty is extended to the original purchaser of the spa produced by Lloyd's Material Supply company, Inc. Which Manufactures the Cal Spas brand portable spa manufactured after January 1st, 2025 and installed for residential use in the United States of America and Canada. This Warranty begins on the date of delivery of the spa, but in no event later than one year from the date of manufacture.

### Swim Spas

<b>Structural</b>	Warrantied against spa shell collapse, leaks caused by the shell, or dangers of structural integrity due to defects in the spa shell.	<b>10 Years</b>
<b>Shell Surface</b>	Warrantied against spontaneous blistering, cracking, or delaminating of the interior spa shell.	<b>7 Years</b>
<b>Equipment &amp; Controls</b>	Electrical Equipment- limited to spa pumps, standard heater, and control system/panels, are warrantied against malfunction due to defects in workmanship or materials.	<b>5 Years</b>
<b>Plumbing</b>	Warrantied against leaks/cracks due to defects in workmanship or materials	<b>5 Years</b>
<b>Spa Cabinet</b>	Warrantied against defects in workmanship or materials. Normal wear and weathering of the finish will occur naturally over time and are not defects.	<b>5 Years</b>
<b>Sanitation</b>	Salt cells & bromine generators are warrantied against defects in workmanship or materials, this includes sanitation control panels & electrical.	<b>1 Year</b>
<b>Ozone/UV</b>	Ozone Generators and UV treatment systems are warrantied against defects in workmanship and materials. (Excluding UV bulbs older than one year)	<b>2 Years</b>
<b>LED Lighting</b>	LED lights are warrantied against malfunction due to defects in workmanship and materials	<b>2 Years</b>
<b>Sound System</b>	The Freedom Sound System is warrantied against malfunction due to defects in workmanship and materials. This does not cover normal wear and tear.	<b>1 Year</b>
<b>Spa Cover</b>	The spa cover is warrantied against malfunction due to defects in workmanship and materials. This does not cover normal wear and tear.	<b>3 Years</b>

### Warranty for Other Components

The fuses, headrests, cal grip, labels, and filters are warrantied to be free of defects in workmanship and material at the time of delivery. All other factory-installed components not mentioned specifically, including, but not limited to the wood frame, jets, diverter valves, filter lids, and other mechanical components, are warrantied against malfunction due to defects in workmanship and material for two years from the original date of delivery. This warranty is void if the spa has endured neglect, chemical abuse, or use of unapproved chemicals or components.

## Structural

This limited warranty covers defects within the spas fiberglass structural shell. This includes sudden spa shell collapse, leaking through the shell, and separation between the spa shell and spa acrylic, caused by faulty bonding. This does not include separation due to micro-abrasions, pin holes in the shell, or warping/bubbling due to sun exposure. This limited warranty does not apply when abuse of the spa shell is evident. This includes but is not limited to, heavy impact craters, fractures on the spa surface due to poor spa care, sun exposure, or reckless use of the spa, and chemical abuse of the spa. This warranty does not cover damage caused by unlevelled ground. Spas must rest on level ground, ideally on a cement slab of 3-6" of thickness depending on the spa weight. Spas that are not placed on a leveled foundation are prone to cracks, delamination, and compromised structural rigidity of the spa. It is the responsibility of the spa owner to ensure that the spas foundation is leveled and inspected before placing the spa.

## Shell Surface

This limited warranty covers defects on the spas acrylic surface due to workmanship or materials. This covers wrinkles on the acrylic, blistering, peeling, delamination, or spontaneous cracking. This warranty does not cover shell damage caused by chemical abuse, improper water chemistry, excessive sun exposure, micro-abrasions, or damage caused by impacts or sharp objects. This warranty does not cover discoloration, or deterioration of the spa shell when exposed to improper chemistry levels, hard water, soft water, or chemical abuse.

## Equipment and Controls

This limited warranty covers malfunction of factory installed spa control systems, spa control panels, spa heater, and spa pumps due to defects in workmanship or materials. This covers sudden control box failure, malfunction of control panels or control boxes, malfunctioning heaters, and malfunctioning spa pumps. This warranty coverage is void if the electrical installation of the spa does not follow the outlined diagrams and specifications, mentioned in this manual. Failure to properly follow the specified GFCI requirements, wire type, wire thickness, compliance with NEC guidelines and local codes will void your warranty. This warranty does not cover acts of god or nature that can damage spa equipment, such examples are flooding, lightning strikes, wildfires, or other scenarios out of the control of the manufacturer.

## Plumbing

This limited warranty covers leaking of water through plumbing joints, tees, hoses, water features, and jet body grommets due to defects in workmanship and materials. This warranty does not cover damage caused by chemical abuse, improper water chemistry, or use of unapproved chemicals/sanitizers. This warranty does not cover freeze damage caused by frozen water expanding within the plumbing of the spa. The winterization procedure within this manual does not guarantee freeze damage prevention. The best method to ensure the spa does not encounter frozen water within the plumbing is to have the spa operating during the colder months of the year. This warranty does not cover freeze damage or damage to the plumbing due to acts of god and/or nature including but not limited to snowstorms, blizzards, power outages, etc. This warranty does not cover oxidation or warping of jets due to chemical abuse or exposing an empty spa to the elements with no secured cover.

## Spa Cabinet

This limited warranty covers defects in workmanship and materials of spa cabinet panels. This warranty applies for warping of spa panels, cracking of corners and panels without clear impact markers, and buckling of spa panels. This warranty does not cover natural wear and tear, which occurs with plastics exposed to the sun. This warranty does not cover panel damage from excessive heat sources, calcium/water-spot build up from sprinklers or irrigation systems, or impact damage. Each claim for spa cabinets are evaluated on a case by case basis, it is the responsibility of the spa owner to acknowledge environmental factors, that can affect the maintenance of the spas cabinet panels. Using plastic spa protectants can prolong the life of your spa panels is highly recommended in high UV index climates. Deterioration/fading of color, natural wear and tear of plastic materials is expected over time, and is not considered a defect in materials. This coverage does not extend nor cover acts of god or nature that can damage spa panels, such examples are flooding, high winds, wildfires, tornadoes or other scenarios out of the control of the manufacturer

### Sanitation

This limited warranty covers malfunctions of factory installed Salt Systems and Bromine generators, which are warranted against malfunction due to defects in workmanship or materials. This includes the salt cell, sanitizer control panels, bromine generator, and power supplies for Cal Salt systems. This warranty does not cover negligent operation of sanitizer systems, chemical abuse, damage caused by improper water chemistry, or disregard of specified data points for safe operation; including but not limited to, incorrect ppm levels of salts, excess operating hours of the Cal Salt cell, or improper maintenance of sanitation components. The spa filter is not a part of this warranty, and is considered a disposable item subject to regular wear and tear.

### Ozone/UV Systems

This limited warranty covers malfunctions of factory installed Ozone and/or UV water treatment systems. This includes leaks through welded components, water back-flow into the ozone generator, and short circuited Ozone or UV systems. This warranty does not cover UV bulbs that are older than 10 months, the UV light must be replaced every 10-12 months as this is normal wear and tear of component. This warranty is voided if alterations/modifications of these systems are evident, or if the spa electrical connections were not installed in accordance to defined specifications within this manual, evidence of chemical abuse, and acts of god and/or nature.

### Sound System

This limited warranty covers malfunctions of factory installed sound system components. This includes the subwoofer/amplifier, speakers, speaker grills, power supply, or Bluetooth antenna. Natural wear and tear of speaker cones is not covered by this warranty, nor are deterioration of speakers exposed to chemical abuse.

### Spa Cover

The spa cover is warranted against defects of materials and workmanship for the defined period mentioned in this warranty. Exposure to UV rays on untreated or poorly maintained spa covers are not covered by this warranty. It is the responsibility of the spa owner to use spa UV plastic protectants on their spa covers, especially in high UV index climates. Exposure to UV light without proper treatment leads to problems such as cracking/peeling of vinyl covers, and sudden fading of color. This warranty does not warrant against damage caused by chemical abuse, nor yellowing or oxidation of the spa cover when exposed to excess sanitizer. If a defect is found within the first 90 days of ownership, your Cal Spas dealer and Cal Spas can directly assist the spa owner filing a claim and replacing the spa cover if deemed necessary. Spa owners with spa covers past the 90 day period that are discovered to have a defect, can contact your Cal Spa dealer to begin the process of filing a claim. When filing a claim of a spa cover than is older than 90 days, this warranty will cover the material cost of issuing a new vinyl sleeve for the cover, and/or replacement foam for your cover. Shipping/freight costs are not covered in this warranty, and are the sole responsibility of the spa owner. Images of the cover from all sides including the top and underside are necessary to file a claim.

### Genuine Cal Spas Parts & Accessories

This Limited Warranty is void if Lloyd's Material Supply Company, Inc., Manufacturer of the Cal Spas brand or its designated representative determines that the spa has been subjected to damage or failure due to installation of aftermarket parts that are not genuine Cal Spas branded parts and accessories. This disclaimer includes, but is not limited to filters, UV bulbs, ozone systems, salt systems, replacement parts and other accessories. Genuine Cal Spas brand parts and accessories are built to our highest standards of quality, durability and performance, and they are designed to work with your spa to ensure optimal performance and function. Only parts/components approved by Cal Spas should used when performing a warranty repair. If parts are required to complete a warranty claim, the cost of the parts are covered by this warranty. Approved labor and genuine part costs are covered when a warranty claim is approved, the cost of shipping parts/components is not covered by this warranty, and its the sole responsibility of the spa owner.



## Performance

This warranty begins on the date of delivery of the spa, but in no event later than one year from the date of manufacture. To obtain service in the event of a defect covered by this Limited Warranty, notify your Cal Spas dealer or Cal spas as soon as possible and use all reasonable means to protect the spa from further damage. Upon proof of purchase, a designated service representative will correct the defect subject to the terms and conditions contained in this Limited Warranty. There will be no charge for parts or Labor to repair the defect, although providing access to affect the repair is your responsibility as the spa owner. Freight charges for replacement parts is the responsibility of the spa owner. Parts and components can be shipped to the servicing dealer or to the customer. The servicing dealer may charge the owner a travel/service fee as well as a diagnose fee if the cause of the issue is unknown, these charges are not covered under warranty. Your spa dealer nor Cal Spas is responsible for damages or costs to rebuild decks, cement structures, or other decor/structures placed against the sides of the spa. Minimum clearance of 3 feet on each side is mandatory for all spas. In the event that the spa is removed to a repair facility for repair and reinstalled, the cost of removal and re-installation will be your responsibility as the spa owner. If Lloyd's Material Supply Company Inc., The manufacture of the Cal Spa brand determines that repair of the covered defect is not feasible, it reserves the right to provide a replacement spa of equal or lesser value to the original purchase price. In such an event reasonable costs for removal of the original spa, shipping costs from the factory for the replacement spa, and delivery and installation of the replacement spa will be the responsibility of the spa owner. The replacement spa will carry the balance of the original spa's warranty. Spa covers are not included. This warranty ends either by specified time frame, owner-transfer of the spa, relocation, or installation of any component other than by the manufacture. If the desired spa is more expensive than what the spa owner originally financed or paid for, the price difference shall be paid by the spa owner. Additional costs can be incurred if the use of heavy machinery such as a crane, bulldozer, etc, is considered necessary to access, remove, or perform a repair/correction to the affected spa.

## Warranty limitations

This Limited Warranty is void if Cal Spas or its designated representative determines that the spa has been subjected to alteration, neglect, misuse or abuse, or freight damage caused by the common carrier; any repairs have been attempted by anyone other than a designated representative; or if the failure is caused by accident, acts of God or other causes beyond the control of the Manufacturer including acts of nature (damage caused by animals, rodents, or other pests) are not covered by this warranty. Additionally; the limited warranty is void for spas that were subject to neglect, misuse and abuse including any installation, operation or maintenance of the spa other than in accordance with the instructions contained in the owner's manual provided with the spa, including but not limited to the failure to maintain proper water chemistry, chemical balancing, the use of abrasives or improper cleaners, and the use of non-genuine parts and accessories. This Limited Warranty does not provide coverage for any item attached to or installed on the spa after the date of manufacture or for gaining access to any component for repair or replacement. Spa units in commercial use are excluded from any coverage whatsoever. The spa owner accepts liability for repair work performed by anyone other than Lloyd's Material Supply Company Inc, or a designated Cal Spas representative. This Limited Warranty is void if damage occurs to the spa shell because of excessive heat buildup due to failure to cover a spa that is empty of water while exposed to direct sunlight.

## Proration of Warranty

Units determined by the manufacture to be non-repairable will be replaced on a prorated basis with the same or a comparable unit. The owner will be charged 1% of the current retail cost for each full month of ownership from the date of purchase through the date failure is determined to be non-repairable. This charge will be waived during the first 6 months of ownership. [example]: Product failure is determined during seven months of ownership. Owner will be responsible to pay for 7% of the products current cost. As the spa owner you have the choice to replace the spa, with a spa equal to or less than the value of the originally financed/purchased spa; if the desired replacement spa is of a higher cost than the originally financed/purchased spa, the spa owner will pay the difference of price, including any percent value lost over time through the spas proration period. The cost of shipping a new spa and its installation is not covered by this warranty as stated in the "Performance" section of this warranty.

### Limitations

The manufacture disclaims all warranties, expressed or implies, in fact or in law, to the extent allowed by your State's law, including the warranty of merchantability and fitness for use, except as stated specifically herein. All warranty service must be performed by the manufacture or its designated representative using authorized Cal Spas parts. No agent, dealer, distributor, service company, or other party is authorized to change, modify, or extend the terms of this limited warranty in any manner whatsoever. The manufacture will not be responsible for any statements or representations made in any form that go beyond, are broader than, or are inconsistent with any authorized literature or specifications furnished by Cal Spas. Extended warranties or care plans offered to you by a spa dealer is an agreement strictly between the spa owner and the spa dealer, out of the control of the manufacture of Cal Spas.

### Disclaimers

Lloyd's Material Supply Company, Inc., Manufacture of Cal Spas brand and its representatives shall not be liable for any injury, loss, cost, or other damage whether incidental or consequential, arising out of any defect covered by this limited warranty, including without limitation, loss of use of the spa and cost for removal of defective produce even if the manufacture was advised of the possibility of damage. The liability of the manufacture under this limited warranty, if any shall not exceed the original amount paid for the defective product. Coverage under this limited warranty shall commence as of the original date of delivery and the duration of such coverage shall not extend for any reason whatsoever beyond the stated time periods. These disclaimers shall be equally applicable to any service provided by the manufacture and its designated representatives.

### Legal Rights

This limited warranty gives you specific legal rights. You may also have other rights that vary from state to state depending on consumer regulations. Some states do not allow limitations on how long an implied warranty lasts, so this time limitation may not apply to you.

### Additional Disclaimers

Spa owners who have purchased a Cal Spa, and the spas final resting place is not in the United States or Canada, Cal Spas will be able to send components and parts directly to the spa customer if the original Cal Spa dealer is not within range of the spa. It is the responsibility of the spa owner to find a experienced electrician, plumber, or technician to perform the necessary repairs. A preliminary over the phone technical meeting with a Cal Spas representative is necessary, to ensure the experienced laborer is familiar with the spas operation, and recommended repair methods. Labor costs of a repair in such circumstances must be first approved by a Cal Spas representative, before moving forward with any repairs covered in this warranty. It is advised to request a labor quote from said experienced laborer, and to send this quote to a Cal Spas representative. If all prerequisites are met and the repair is approved, Cal Spas will reimburse the cost of labor directly to the spa owner upon completion of repairs. Reimbursements of charged labor will be sent as a check to the spa owners residence, with a varying estimated disbursement window.

For all repairs/warranty claims within the United States and Canada and other nations, may be required to send parts/components back to Cal Spas when deemed necessary. In some circumstance where shipping the component/part is necessary, Cal Spas will provide a shipping label to send the affected or requested components/parts. It is the responsibility of the spa owner to properly package and secure the package for shipping. In some circumstances only images and proof of purchase would be necessary to file a warranty claim, in such circumstances if a Cal Spas representative deems that the parts do not have to be returned, follow all local regulations and laws to properly dispose of said components.

This Page is Intentionally Blank





[www.CalSpas.com](http://www.CalSpas.com)

**CONTACT INFORMATION**

For customer service or service technicians, please contact your authorized dealer immediately. If you need additional information and/or assistance, contact

**CAL SPAS**

*Lloyd's Material Supply Company, Inc.*  
Customer Service Department  
1462 East Ninth Street, Pomona, CA 91766

**Toll Free: 1-800-CAL-SPAS**  
Fax: 1-909-629-3890

**LTR.2026.1146**  
**2/27/2026 Rev E**